

Fhlanett Phatt

OPERATION MANUAL



E-mu Systems, Inc.



The Swing System

Operation Manual

© 1996 E-mu Systems, Inc.
All Rights Reserved

• **FI542 Rev. B**

E-mu World Headquarters

E-mu Systems, Inc. U.S.A.
P.O. Box 660015
Scotts Valley, CA USA
95067-0015
Telephone: 408-438-1921
Fax: 408-438-8612

Europe, Africa, Middle East

E-mu Systems, Ltd.
Suite 6, Adam Ferguson House
Eskmills Industrial Park
Musselburgh, East Lothian
Scotland, EH21 7PQ
Telephone: +44 (0) 131-653-6556
Fax: +44 (0) 131-665-0473

Important Notice:

In order to obtain warranty service on your Planet Phatt unit, the serial number sticker must be intact and you must have a sales receipt or other proof of purchase. If there is no serial number sticker on your Planet Phatt, please contact E-mu Systems at once.

This product is covered under one or more of the following U.S. patents: 4,404,529; 4,506,579; 4,699,038; 4,987,600; 5,013,105; 5,072,645; 5,111,727; 5,144,676; 5,170,367; 5,248,845; 5,303,309; 5,317,104; 5,342,990; 5,430,244 and foreign patents and/or pending patents. Planet Phatt is a registered trademark of E-mu Systems, Inc.

IMPORTANT SAFETY INSTRUCTIONS

Use in countries other than the U.S.A. may require the use of a different line cord or attachment plug, or both. To reduce the risk of fire or electric shock, refer servicing to qualified service personnel. To reduce risk of fire or electric shock do not expose this product to rain or moisture.

GROUNDING INSTRUCTIONS

This product must be grounded. If it should malfunction or break down, grounding provides a path of least resistance for electric current, reducing the risk of electric shock. This product is equipped with a cord having an equipment-grounding conductor and a grounding plug. The plug must be plugged into an appropriate outlet properly installed and grounded in accordance with all local codes and ordinances.

DANGER

Improper connection of equipment grounding conductor can result in the risk of electric shock. Check with a qualified electrician or service personnel if you are in doubt as to whether the product is properly grounded. Do not modify the plug provided with this product — if it will not fit the outlet, have a proper outlet installed by a qualified technician.

CAUTION

If the 9091, Planet Phatt is rack mounted, a standard 19-inch open frame rack must be used.

USER-MAINTENANCE INSTRUCTIONS

1. Planet Phatt should be kept clean and dust free. Periodically wipe the unit with a clean, lint free cloth. Do not use solvents or cleaners.
2. There are no user lubrication or adjustment requirements.
3. Refer all other servicing to qualified service personnel.

INSTRUCTIONS PERTAINING TO A RISK OF FIRE, ELECTRIC SHOCK, OR INJURY TO PERSONS

WARNING; When using electric products, basic precautions should always be followed, including the following:

1. Read all instructions before using Planet Phatt.
2. To reduce the risk of injury, close supervision is necessary when Planet Phatt is used near children.
3. Do not use Planet Phatt near water — for example near a bathtub, wash-bowl, kitchen sink, in a wet basement, on a wet bar, or near or in a swimming pool.



This symbol is intended to alert the user to the presence of important operating and maintenance (servicing) instructions in the literature accompanying the appliance.

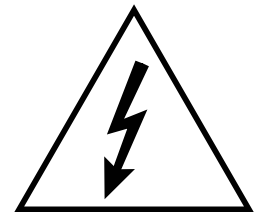

This symbol is intended to alert the user to the presence of uninsulated dangerous voltage within the product's enclosure that may be of sufficient magnitude to constitute a risk of electric shock to persons.

SAVE THESE INSTRUCTIONS

4. Planet Phatt should be situated so that its location or position does not interfere with its proper ventilation.
5. Planet Phatt should be located away from heat sources such as radiators, heat registers, fireplaces, stoves, or ovens.
6. Planet Phatt should only be connected to a power supply of the type described in the operating instructions and as marked on the product.
7. This product, in combination with an amplifier, headphones, and speakers, may be capable of producing sound levels that could cause full or partial hearing loss or damaged equipment. Do not operate for long periods of time at high volume levels or at a level that is uncomfortable. Additionally, care must be taken when programming any of the filters contained herein using extreme operating parameters. This action could also produce signals which result in unacceptable high sound levels as noted previously. If you experience any hearing loss or ringing of the ears consult your physician.
8. Planet Phatt may be equipped with a polarized line plug (one blade wider than the other). This is a safety feature. If you are unable to insert this plug into the outlet, do not defeat the safety purpose of the plug. Contact an electrician to replace your obsolete outlet.
9. The power supply cord of Planet Phatt should be unplugged from the outlet when left unused for a long period of time.
10. Care should be taken so that objects do not fall and liquids are not spilled into the enclosure of Planet Phatt through openings.
11. The product should be serviced by qualified service personnel when:
 - A. The power supply cord has been damaged; or
 - B. Objects have fallen, or liquid has been spilled into the product; or
 - C. The product has been exposed to rain; or
 - D. The product does not appear to operate normally or exhibits a marked change in performance; or
 - E. The product has been dropped or the enclosure damaged.
12. All servicing should be referred to qualified service personnel.

SAVE THESE INSTRUCTIONS

INTRODUCTION & BASIC SETUP	1
<i>Introduction</i>	3
<i>Planet Phatt Architecture</i>	4
<i>Connection Instructions</i>	5
BASIC OPERATION	9
<i>Main Controls</i>	11
<i>Selecting MIDI Channels</i>	12
<i>Selecting Presets</i>	12
<i>Adjusting Volume & Pan Position</i>	12
<i>Beats/Song Mode</i>	13
<i>Multi-Timbral Operation</i>	17
<i>About Planet Phatt</i>	18
MASTER MENU	19
<i>Enabling the Master Menu</i>	21
<i>Master Tune</i>	21
<i>Transpose</i>	22
<i>Global Bend</i>	22
<i>Global Velocity Curve</i>	22
<i>Mix Output</i>	24
<i>MIDI Mode</i>	24
<i>MIDI Mode Change</i>	25
<i>MIDI Overflow</i>	25
<i>MIDI Enable</i>	25
<i>MIDI Bank Select</i>	25
<i>MIDI Program → Preset</i>	26
<i>Preset Change</i>	27
<i>MIDI Controller Assign</i>	27
<i>X Factor Control</i>	27
<i>Tempo Control</i>	28
<i>Retrigger</i>	28
<i>Pitch Wheel -> Scratch</i>	29
<i>MIDI Footswitch Assign</i>	29
<i>Send MIDI Data</i>	30
<i>Beats MIDI Out</i>	31
<i>User Key Tuning</i>	31
<i>Song Start/Stop</i>	31
<i>Global Tempo</i>	32

MASTER MENU (continued)

<i>Beats Control</i>	32
<i>Beats Mode</i>	33
<i>Demo Sequence</i>	33
<i>Viewing Angle</i>	34

PROGRAMMING BASICS 35

<i>Modulation</i>	38
<i>Modulation Sources</i>	39
<i>Envelope Generators</i>	40
<i>Low Frequency Oscillators</i>	41
<i>MIDI Patch</i>	42
<i>Filter Modulation</i>	43
<i>What is a Filter?</i>	43
<i>Parametric Filters</i>	46
<i>The Z-Plane Filter</i>	46
<i>Planet Phatt Signal Flow</i>	48
<i>Keyboard & Velocity Modulation</i>	49
<i>Key Number</i>	50
<i>Velocity Curves</i>	50
<i>Realtime Modulation</i>	51
<i>MIDI Realtime Controls</i>	52
<i>Stereo Mix Outputs</i>	54

EDIT MENU 55

<i>Enabling the Edit Menu</i>	57
<i>Preset Name</i>	58
<i>Primary Instrument</i>	59
<i>Secondary Instrument</i>	59
<i>Key Range</i>	59
<i>Primary Key Range</i>	60
<i>Secondary Key Range</i>	60
<i>Coarse Tuning</i>	61
<i>Fine Tuning</i>	61
<i>Volume</i>	61
<i>Pan</i>	61
<i>Alternate Envelope On/Off</i>	62
<i>Primary Alternate Envelope Parameters</i>	62
<i>Secondary Alternate Envelope Parameters</i>	62
<i>Delay</i>	63
<i>Sound Start</i>	63

EDIT MENU (continued)

<i>Reverse Sound</i>	63
<i>Solo Mode</i>	64
<i>Portamento Rate</i>	64
<i>Chorus</i>	64
<i>Crossfade Mode</i>	65
<i>Crossfade Direction</i>	66
<i>Crossfade Balance</i>	66
<i>Crossfade Amount</i>	67
<i>Cross-switch Point</i>	67
<i>Primary Filter Type</i>	67
<i>Primary Filter Cutoff & Q</i>	69
<i>Secondary Filter Type</i>	69
<i>Secondary Filter Cutoff & Q</i>	69
<i>Auxiliary Envelope</i>	70
<i>LFO 1 - Shape & Amount</i>	71
<i>LFO 1 - Rate, Delay & Variation</i>	71
<i>LFO 2 - Shape & Amount</i>	72
<i>LFO 2 - Rate, Delay & Variation</i>	72
<i>Keyboard & Velocity Modulation Control</i>	73
<i>Realtime Modulation Control</i>	74
<i>Footswitch Control</i>	75
<i>Pitch Bend Range</i>	75
<i>Pressure Amount</i>	75
<i>MIDI Controller Amount</i>	75
<i>Velocity Curve</i>	76
<i>Keyboard Center</i>	77
<i>Keyboard Tuning</i>	77
<i>Mix Output Assign</i>	78
<i>Preset Links</i>	78
<i>Save Preset</i>	79

STEP-BY-STEP

81

<i>Linking Presets</i>	83
<i>Editing Presets</i>	84
<i>Changing the Tuning of an Instrument</i>	84
<i>Chorus</i>	85
<i>Reversing the Instrument</i>	85
<i>Alternate Volume Envelope</i>	86
<i>Working with the Filter</i>	87
<i>Using Planet Phatt with a Sequencer</i>	92

REFERENCE SECTION	95
<i>Preset Listing</i>	96
<i>Instrument Listing</i>	101
<i>Beat Maps</i>	106
<i>Technical Specifications</i>	109
<i>MIDI Specifications</i>	110
<i>Warranty</i>	126
<i>Index</i>	127

PLAQUE
PLAQUE

INTRODUCTION & BASIC SETUP



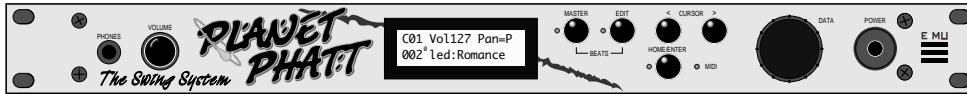

PLANET PHATT - The Swing System

Planet Phatt is a professional tone module created specifically for Hip-Hop, Rap, Acid Jazz and Trip-Hop musicians. Planet Phatt is 16 part multi-timbral, featuring 32 voices of polyphony and 640 presets (384 ROM, 256 RAM). It is a superb song writing tool and a perfect addition to the modern keyboard player's studio or live setup.

Planet Phatt is also equipped with our exclusive “BEATS” mode. 100 user-editable drum loops are stored in memory and can be synchronized to internal or external MIDI clock. The combination of beats, tempo, any preset and the powerful “X-Factor” control allow you to create literally *millions* of new groove ideas. Your custom Beats can also be linked into 28 user-programmable *Songs* with looping and programmable jumps. Beats and Songs can be easily modified to fit your style.

There are 640 presets on Planet Phatt, created by talented E-mu programmers and other industry experts. Of course you can edit or modify any and all parameters to create a limitless number of entirely new sounds. Edit and tweak Planet Phatt’s sounds the way you like them by using its powerful filters, MIDI synced LFO’s, and MIDIPatch modulation system. Planet Phatt has plenty of real-time controls and destinations that allow users to create floor-slamming, heart-pounding masterpieces. Creating your own original sounds is easy, thanks to Planet Phatt's logical user interface.

Other features include 3 stereo outputs for externally processing sounds (also configurable as 6 polyphonic submixes with fully programmable dynamic panning), integral sends and returns to allow the addition of external effects units without the need for a separate mixer, user-definable alternate tuning, and of course, an extensive MIDI implementation.

In addition, when coupled with E-mu's *Launchpad Performance Controller*, Planet Phatt becomes a self-contained interactive groove machine for the stage or studio. Check it out...

PLANET PHATT ARCHITECTURE

Planet Phatt is organized as shown in the diagram below.

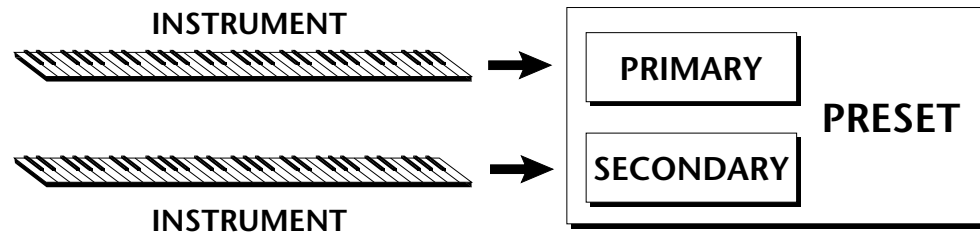

The *Preset* is a complete set of all program parameters for a complete Planet Phatt sound. The fully programmable user presets and the unalterable ROM presets are organized into five banks of 128 presets each.

BANKS 0 & 1 USER PRESETS
BANKS 2 - 4 ROM PRESETS

- **User Presets** can be moved, erased or modified as desired.

- **ROM Presets** cannot be moved or altered unless they are first copied to a user location.

Each preset consists of one or more instruments. An instrument is a complete set of samples or a digital waveform which covers the entire keyboard range. An instrument can be assigned to each of the *Primary* and *Secondary* layers of the preset.

The primary and secondary layers are essentially two complete sounds, stacked or placed adjacent to each other, which can be switched or crossfaded together in various ways.

Up to four presets can be *Linked* in order to have more than one preset on the keyboard at a time. The linked presets may overlap each other for layered sounds or be adjacent to each other to create keyboard “splits”.

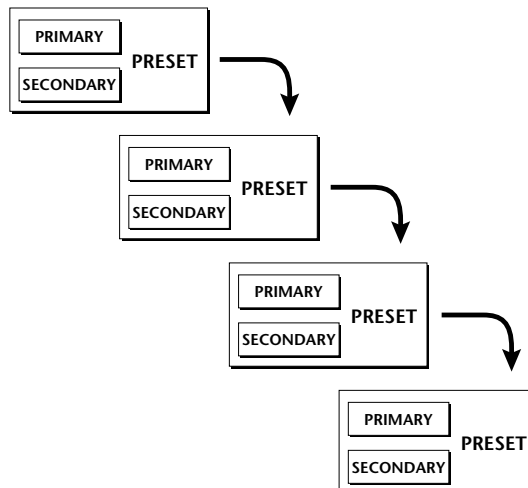

SETUP #1 BASIC SETUP

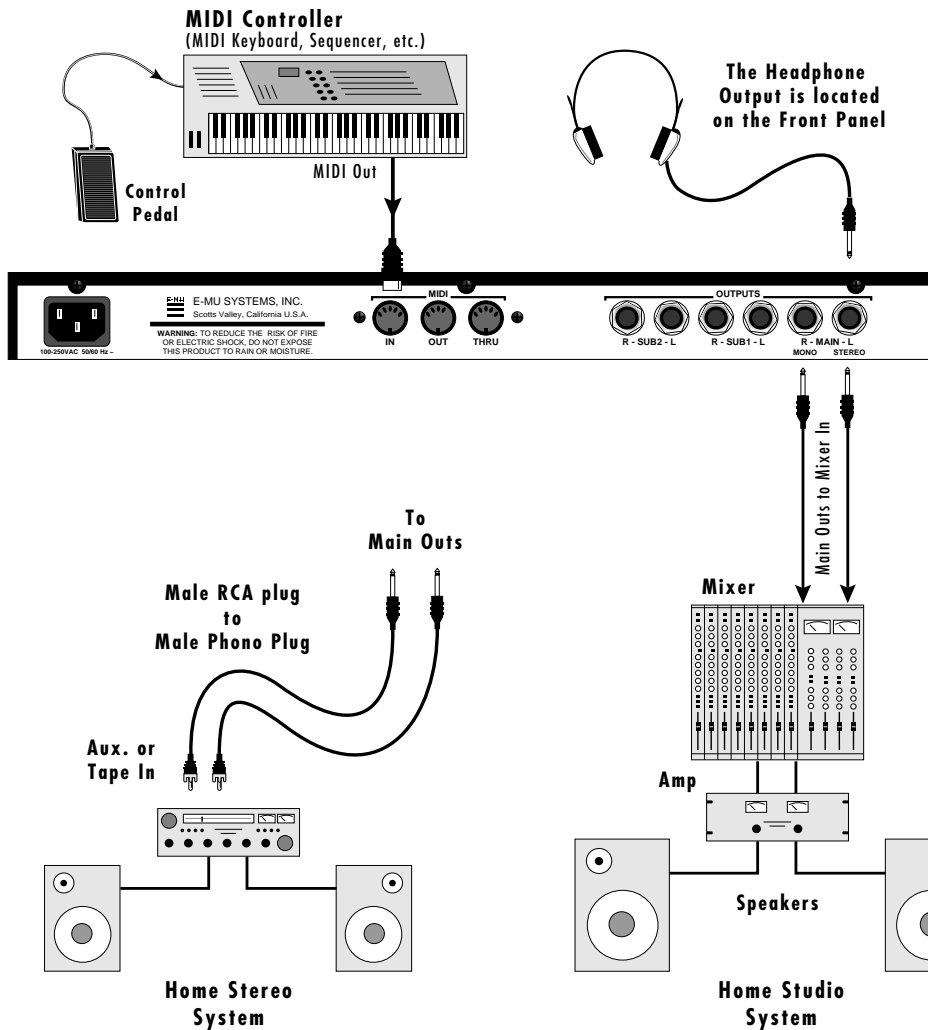

▼ The headphone output monitors the main outputs only. The submix outputs do NOT feed into the headphone output.

••• If Planet Phatt does not seem to be responding correctly, make sure that both Planet Phatt and your MIDI controller are set to the same MIDI channel.

MIDI In

Planet Phatt is controlled by MIDI messages received at the MIDI In connector. Connect the MIDI In of the Planet Phatt to the MIDI Out connector of a MIDI controller such as a MIDI keyboard or MIDI drum pads.

Outputs

Planet Phatt is a high quality, stereo audio device. In order to reproduce its wide dynamic range and frequency response, use a high quality amplification and speaker system such as a keyboard amplifier or home stereo system. A stereo setup is highly desirable because of the added realism of stereophonic sound. Headphones can be used if an amplifier and speaker system is not available. Plug stereo headphones into the headphone jack located on the left side of the front panel. The Right Main output jack serves as a mono output when the Left Main plug is not plugged in.

SETUP #2 STUDIO SETUP

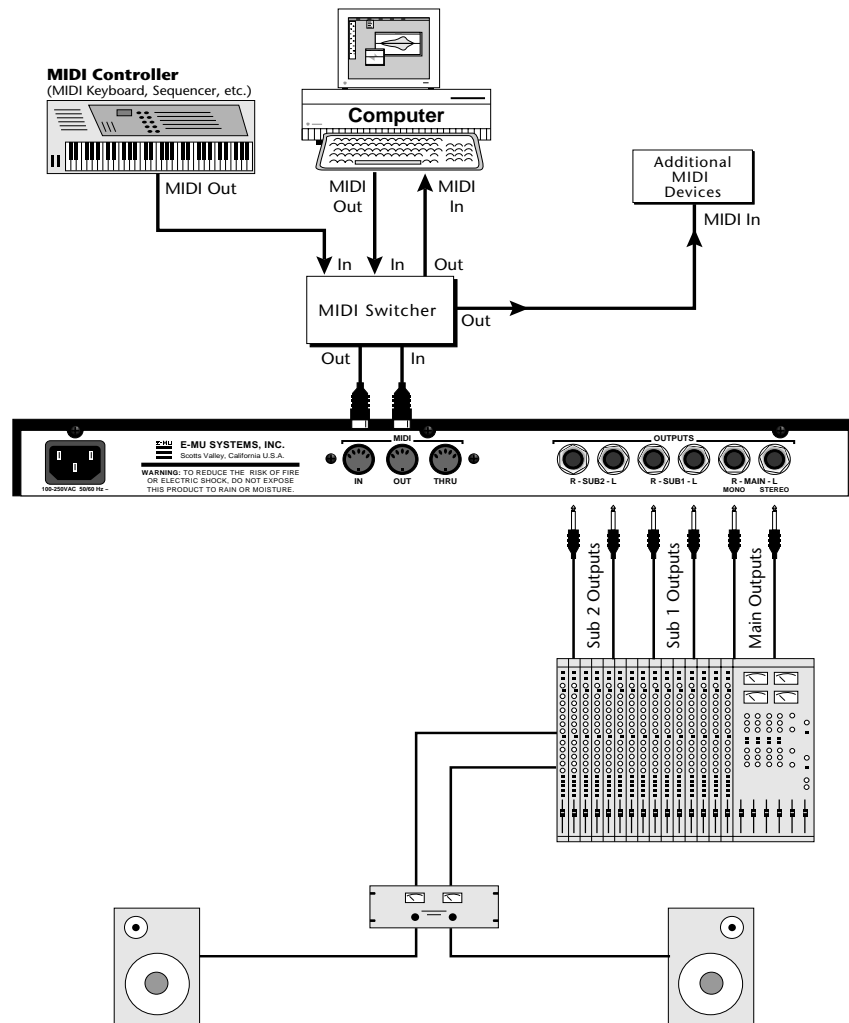

MIDI In

In this setup, Planet Phatt is controlled by MIDI messages received at the MIDI In connector which have been routed by a MIDI switcher. The MIDI switcher allows any MIDI controller such as a MIDI keyboard, MIDI drum pads or a computer to be easily connected.

MIDI Out

The MIDI Out jack is normally used to transmit program data to a computer or other device.

Outputs

Planet Phatt has three sets of programmable stereo outputs; Main, Sub 1, and Sub 2. Specific Planet Phatt presets (or MIDI channels) can be routed to one of these stereo pairs in order to be further processed or mixed separately.

SETUP #3 PERFORMANCE SETUP

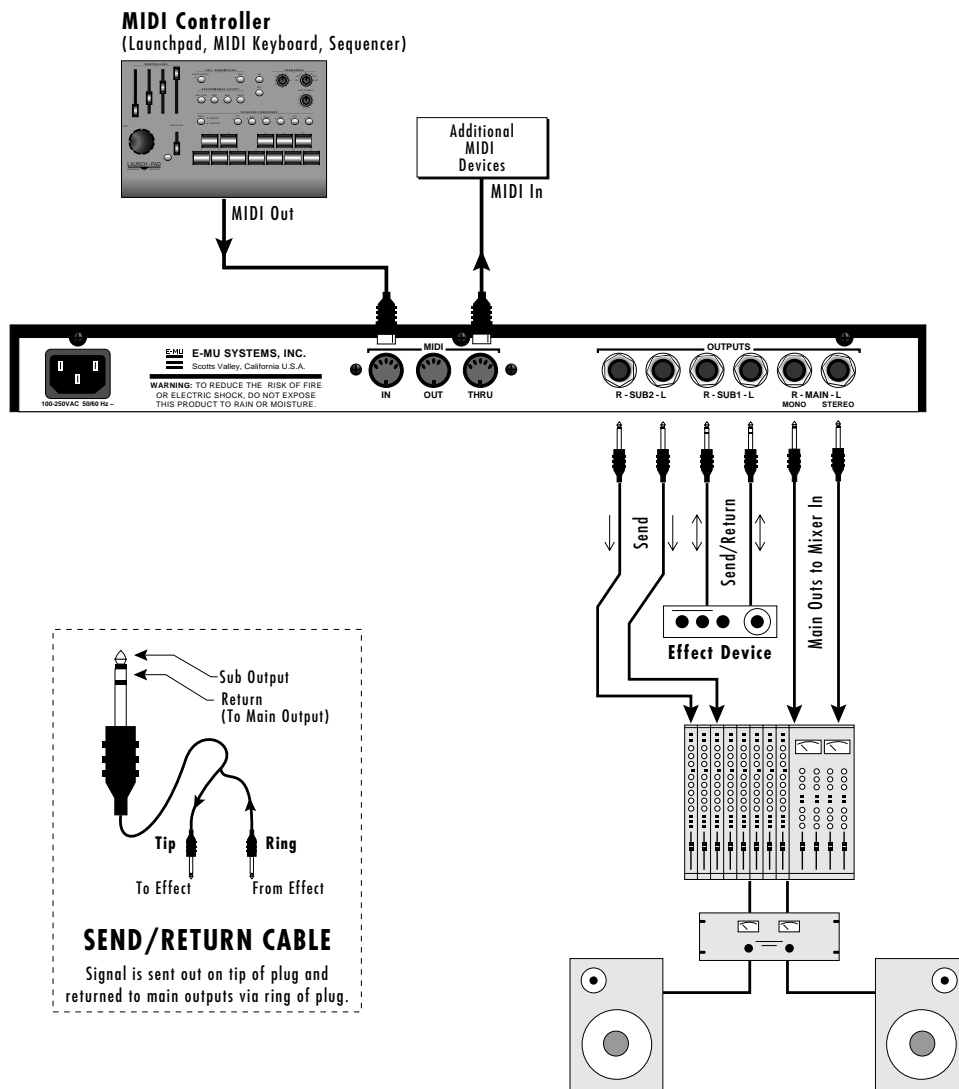

MIDI In

Planet Phatt is controlled by MIDI messages received at the MIDI In connector. Connect the MIDI In of Planet Phatt to the MIDI Out connector of a MIDI controller such as E-mu's Launchpad, a MIDI keyboard, MIDI drum pads or a MIDI sequencer.

MIDI Thru

The MIDI Thru jack is used to connect additional MIDI devices onto the MIDI chain. MIDI Thru transmits an exact copy of the messages received at the MIDI In jack.

Outputs

The Sub 1 and Sub 2 output jacks on Planet Phatt are stereo jacks. The tip of each jack (accessed when a standard phone plug is inserted) connects to the left or right output of that group.

••• Inserting a standard mono phone plug **halfway** into the jack allows you to sum into the main outputs without a special cable.

If a stereo plug is inserted, the Ring of the stereo plug serves as a signal Return which sums into the Main outputs.

Therefore, the Sub 1 and Sub 2 jacks can serve as effect sends and returns in order to further process selected instruments and then return them to the main mix.

The diagram shows the Sub 1 and Sub 2 jacks being used as send/returns in order to further process selected Planet Phatt presets without using the effects bus on the mixing board. In a pinch, the effect returns could also be used to sum additional instruments into the main outputs.

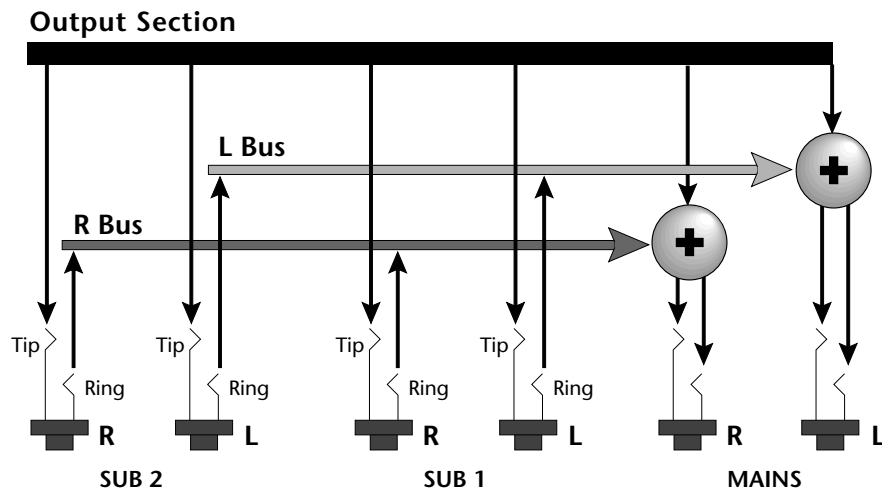

The Sub 1 and Sub 2 jacks can be used as effect returns to the Main Outputs.

POWER UP!

The power switch is located on the right side of the front panel. Planet Phatt and its MIDI controller may be turned on in any order. When power is applied, the liquid crystal display will light, indicating that Planet Phatt is operating. You may have noticed that there is no 110/220 Volt power selector switch on Planet Phatt.

PLANET PHATT AUTOMATICALLY SWITCHES ITSELF TO THE PROPER LINE VOLTAGE.

PLAWEET PHATTI

BASIC OPERATION

MAIN CONTROLS

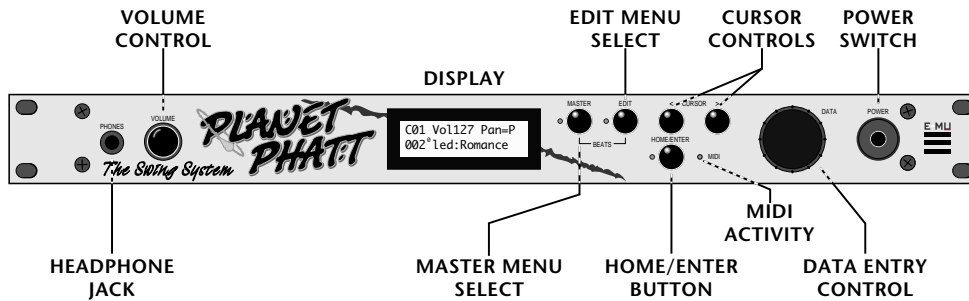

Power Switch

Switches AC power to Planet Phatt On and Off.

MIDI Activity LED

Indicates that MIDI data is being received.

Master Menu Select Button

The Master menu contains parameters that affect the entire machine, not just certain presets. An illuminated LED to the left of the button indicates that you are in the Master menu.

Edit Menu Select Button

The Edit menu is used when you want to change parameters of a preset. An illuminated LED to the left of the button indicates that you are in the Edit menu.

Home/Enter Button

The Home/Enter button is used to initiate a particular operation. The red LED to the left of the enter button flashes to let you know that Planet Phatt is waiting for your response.

Cursor Controls

These buttons move the cursor to the next parameter on the display. (The cursor is a little flashing line underneath one of the parameters in the display.) Press either cursor control repeatedly until the cursor is underneath the desired parameter. The cursor can also be moved bi-directionally using the data entry control while the right cursor select button is being held down (i.e. Press and hold the right cursor button and turn the data entry knob).

Data Entry Control

The data entry control is a stepped, variable control which is used to change parameter values. The control increments or decrements the current value one unit with each click. This control incorporates acceleration (values advance faster if the control is turned quickly).

Volume Control

This is the master volume control for all audio outputs. Note: For maximum dynamic range, set this control to full level.

BASIC OPERATION

••• If Planet Phatt is not responding properly or plays the wrong preset, make sure that both Planet Phatt and your MIDI controller are set to the same MIDI channel and that the MIDI Volume is turned up.

For more information about MIDI, see MIDI Realtime Controls on page 52.

Bank	Contents
0	128 RAM Presets
1	128 RAM Presets
2	128 ROM Presets
3	128 ROM Presets
4	128 ROM Presets

MIDI CHANNEL SELECTION

Press the cursor key repeatedly until the cursor is underneath the channel number. (The cursor is a little flashing line underneath one of the parameters in the display.) Rotate the data entry control to select MIDI channel 01-16. As the channel is changed, the display will change to show the preset, volume and pan associated with the displayed channel.

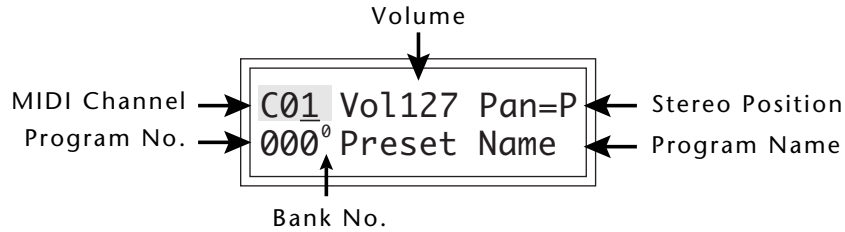

PRESET SELECTION

Press the cursor key repeatedly until the cursor is underneath the program number. (The cursor is a little flashing line underneath one of the parameters in the display.) As the data entry control is rotated, the preset number and name will change. The displayed preset will be assigned to the displayed MIDI channel. Programs are arranged into banks of 128, as shown in the diagram at left. Banks can be selected independently of the of the program number by pressing the the Home/Enter button while turning the the data entry knob.

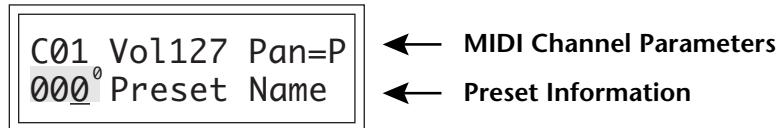

CHANNEL VOLUME

Press the cursor key repeatedly until the cursor is underneath the volume value. Rotate the data entry control to select volume 000-127. (This is the same parameter as MIDI volume control #7, and changes made over MIDI will be shown in the display.)

CHANNEL PAN

Press the cursor key repeatedly until the cursor is underneath the pan value. Rotate the data entry control to select pan values -7 to +7 or "P". When "P" is selected, the pan value specified in the preset is selected. Any other value will override the pan parameter in the preset. (This is the same parameter as MIDI pan control #10, and changes made over MIDI will be shown in the display.)

••• Channel Pan should normally be set to "P" unless realtime control of panning is desired. This will allow the programmed pan setting for each preset to be used.

BEATS MODE

Planet Phatt contains a “Beat Sequencer” which can play any of 100 pre-programmed drum sequences called *Beats*. Any of Planet Phatt's 640 presets can be used with any beat. The *X-Factor* control further multiplies the number of possible beat combinations by changing which instrument is assigned to each individual drum hit.

Beats can be also linked together to form *Songs*. Each song can have up to 10 steps and each step can be programmed to loop up to 64 times or loop indefinitely. Each step of a song can select a certain beat pattern, jump to another step in the song, or jump to the beginning of another song. Because of this jumping capability, songs can be made as complex as you want. Planet Phatt holds a maximum of 28 songs which can be quickly and easily transferred to a MIDI sequencer for backup.

To Enter Beats or Song Mode

1. Press and hold both the Master button and the Edit button. The Beats menu shown below will appear and the Enter LED will be flashing.
2. Press the Enter button to Start the beat or song. The Enter LED will be solidly on and the Master and Edit LEDs will flash once each time the Beat pattern loops.
3. Press either cursor button and use the data entry control to select a new beat or song, change the tempo, transpose the sequence (X-Factor) or change the preset. Song numbers are located immediately after beat 99.
4. Press the Enter button again to Stop the beat or song.
5. Press and hold both the Master button and the Edit button again to return to the main screen. The song or beat will continue playing unless you stopped it using the Enter button. The Master and Edit LEDs will continue to flash, indicating Beats mode is On.

- **To Turn Beats Off** - Return to the Beats menu and press Enter.

Beats mode plays the preset assigned to MIDI channel 16. If you are in Multi-mode, you can play along with beats mode on any of the MIDI channels.

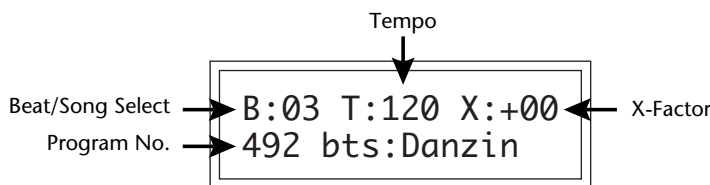

••• The Beat number can be selected remotely by using a MIDI Song Select command. Beats mode can also be started and stopped via a MIDI Song Start and Stop command when the Beats screen is displayed.

••• There are four different Beats modes:
Factory,
1:Constant Tempo,
2:Constant T,X,P
3:User Settings.
 See page 33 for details.

▼ **Warning:** Beware of using Omni mode on multiple channels while Beats are playing. Unpredictable results may occur.

• Beats Mode Parameters

- B:** Selects the beat number. There are 100 different beats to choose from. Unless the Master menu Beats mode is set to option 2:Constant T, X, P, the preset will change when you change the beat.
- T:** Sets the Tempo of the sequence. The tempo is variable from 1 beats-per-minute to 255 bpm. Turning the tempo all the way down selects External Clock mode (Ext). In external clock mode, the tempo is derived from incoming MIDI clock pulses.
- X:** Selects the “X Factor” or transposition interval. Rather than change the pitch of the instruments, transposition shifts the keyboard position up and down. On “Beats” presets this has the effect of changing the instruments on each beat. By combining the various beats, presets and transpositions, you can create literally hundreds of thousands of different grooves. On presets where there is one sound stretched across the entire keyboard, transpose will transpose the pitch.

••• MIDI Song Numbers (0-127) can select either Beats (0-99) or Songs (100-127)

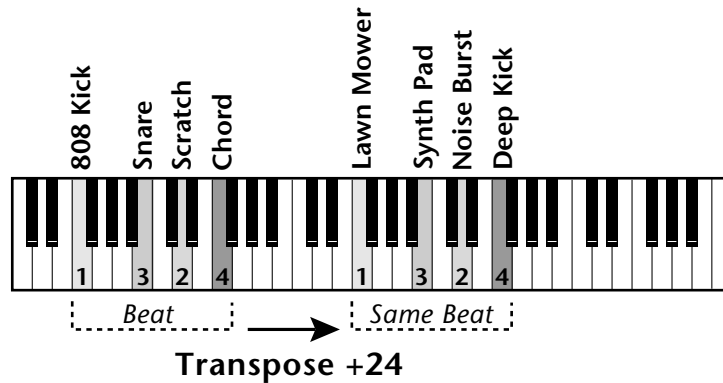

Transposing a “beats” preset shifts the keyboard and changes the sounds assigned to each beat.

SONG MODE

Song mode allows you to link beats together to form more complex and repeatable song structures. Planet Phatt can record up to 28 songs of up to 10 events each, numbered E0 through E9.

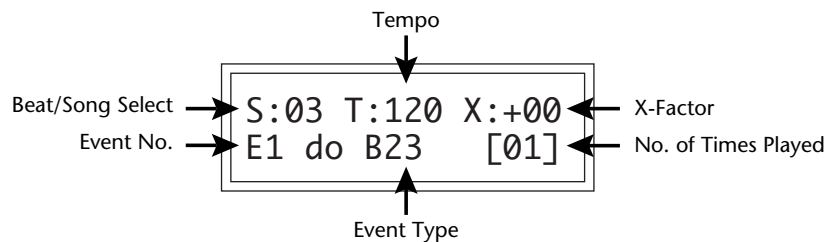

- **Song Mode Parameters**

S: Selects the Song number from S00 to S27. Moving the data entry control one increment past B99 selects the first Song (S00).

T & X: The Tempo and X-Factor can be edited for each event, but will only be saved and recalled if the **Beats Mode** in the Master menu is set to **3:User Settings**.

E: Selects the Event number. An Event can do one of the following things:

- **Play a particular Beat, a specified number of times.**

S:00 T:120 X:+00
E1: do B:05 [10]

→ plays Beat 05 10 times

- **GoTo a Previous Event, and play it a specified number of times.**

S:00 T:120 X:+00
E2: to E1 [04]

→ go back to event E1, play 4 times

- **GoTo a particular new Song.**

S:00 T:120 X:+00
E2: to S05 [--]

→ go to Song S05 NO REPEATS!

- **Stop the Song**

S:00 T:120 X:+00
E2: Stop [--]

→ end of Song NO REPEATS!

[]: Number of times played from 1 to 64. Multiple plays are not allowed on GoTo Song or Stop events. Moving the data entry control one increment past 64 selects **Infinite Repeat** [$\langle \rangle$]

••• See Beats Mode in the Master Menu for additional information.

▼ Warning: The first Event in a Song is always a "Play Beat" Event.

••• Song Beats do not have to begin at event 00. If you select Event 05 and press Enter, the Song will begin playing from event 5.

If the cursor is underneath the Song number, the Song will always begin at Event 0.

• Song Examples

Because of the Repeat and Jump functions, Songs can be made as complex as you like. Remember to set Beats mode (in the Master menu) to “3:User Settings” if you want the Song to play back your own Tempo, X-Factor and Preset settings.

The diagrams below show a few examples of how songs can be constructed.

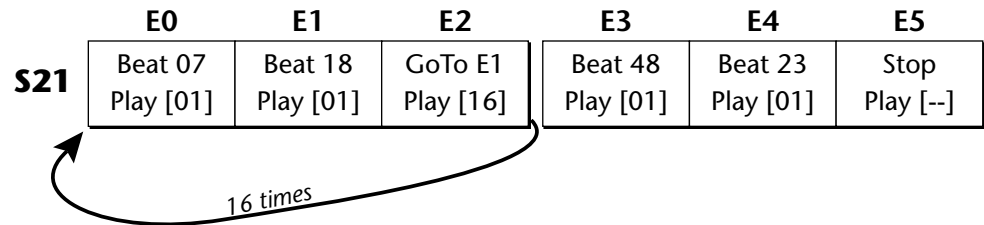

In the above example, beat 7 plays once and then beat 18 plays once. At event E2, the song jumps back and repeats E0 and E1. When events E0 and E1 have looped 16 times, the song moves on to steps E3, E4, and E5, which stops the song.

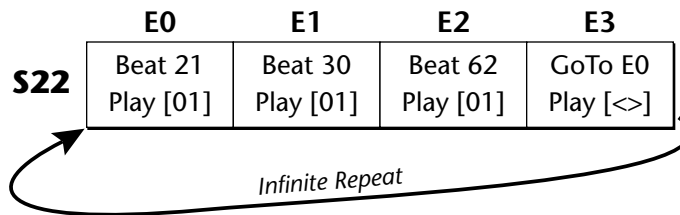

In the above example, beats 21, 30 and 62 are simply repeated indefinitely until you turn off Beat/Song mode.

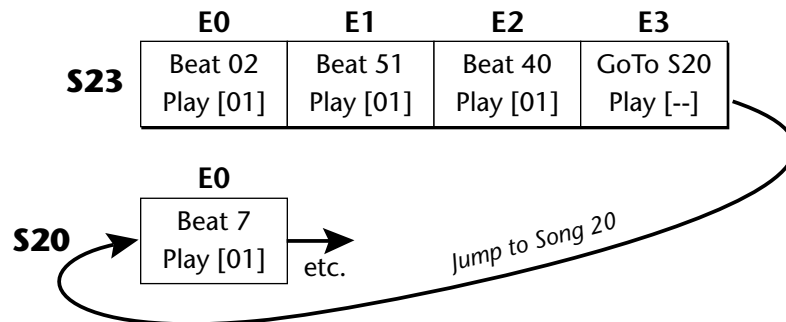

Instead of jumping to a previous step, song 23 jumps to song 20 in the example above. This technique might be used to add a “lead in” to a previously stored song.

MULTI-TIMBRAL OPERATION

Multi-timbral operation means that Planet Phatt can play more than one sound at the same time. To access multiple presets on different MIDI channels simultaneously, follow these instructions:

1. Set the MIDI mode to MULTI-Mode, using the MIDI mode function in the Master menu (page 24).
2. Decide which MIDI channels you wish the Planet Phatt to receive, and turn all other channels OFF using the MIDI Enable function in the Master menu (page 25). *Up to 16 channels can be selected simultaneously!*
3. Select the desired preset for each of the MIDI channels you wish the Planet Phatt to receive using the MIDI Channel/Preset selection screen (see previous instructions).
4. Planet Phatt will now respond multi-timbrally on the MIDI channels you have specified. The volume and pan position parameters can be adjusted over MIDI (for each MIDI channel) or using the Cursor and Data Entry control in the MIDI Channel/Preset selection screen.

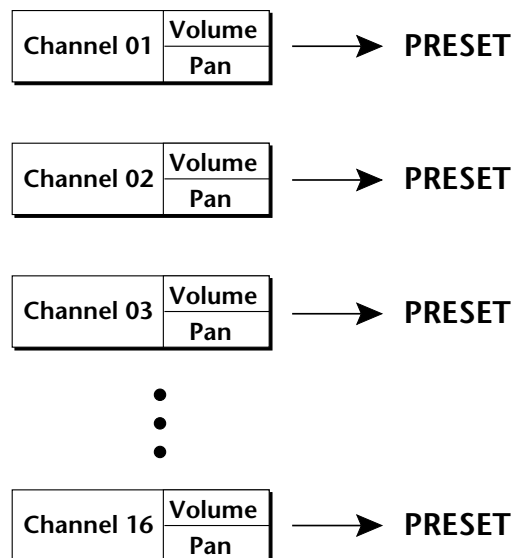

Each of the 16 MIDI channels can be assigned to play a specific Planet Phatt preset.

ABOUT PLANET PHATT

Planet Phatt utilizes digital recordings of real instruments for the basis of its sound. This is similar to a tape recorder except that inside Planet Phatt, the sounds are permanently recorded on digital memory chips.

To perform this modern miracle, sounds and instrument waveforms are first digitally recorded or “sampled”. After the sounds and waveforms have been truncated, looped and processed, they are “masked” into the Planet Phatt ROM (Read Only Memory) chips.

Conceptually, the sampling process is very simple, as shown in the Basic Sampling System diagram. As a sound wave strikes the diaphragm of a microphone, a corresponding voltage is generated. To sample the sound, the voltage level is repeatedly measured at a very high rate and the voltage measurements are stored in memory. To play the sound back, the numbers are read back out of memory, converted back into voltages, then amplified and fed to a speaker which converts the voltage back into sound waves. Of course, playing back 32 channels at different pitches tends to complicate matters, but this is basically how it works. In Planet Phatt, we have left out the Analog/Digital converter stage since the sounds are already sampled for you.

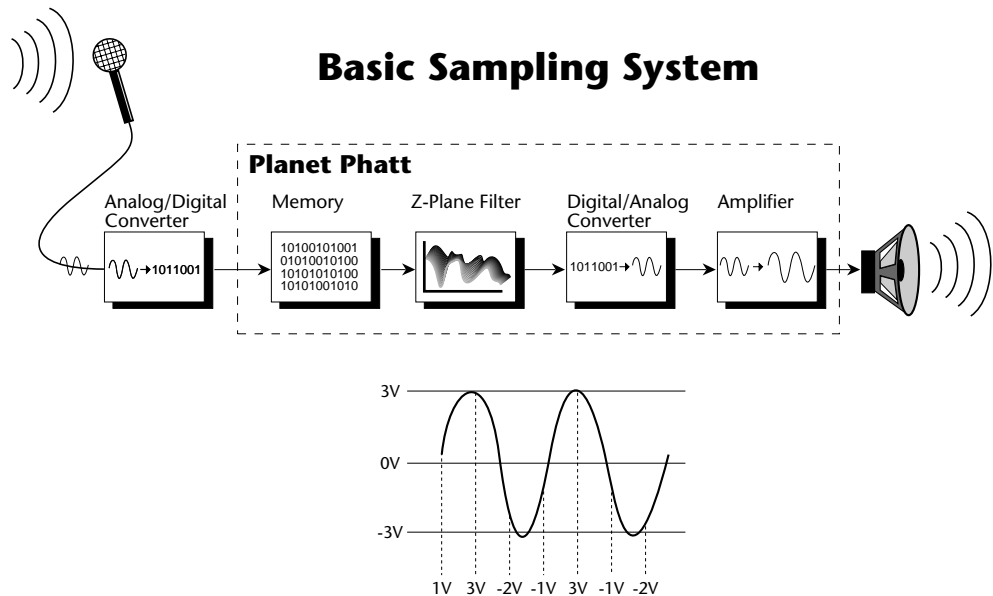

PLAQUE
PHAT

MASTER MENU

MASTER MENU

The Master menu contains functions that affect the overall operation of Planet Phatt. For example, changing the Master Tune will change the tuning of all the presets, not just the one currently displayed.

To enable the Master menu

Press the Master key, lighting the LED. The current screen will be the one most recently selected since powering up Planet Phatt. The cursor will appear underneath the first character of the screen heading on line one.

To select a new screen

Press the cursor key repeatedly (or hold the right cursor key while turning the data entry control) until the cursor is underneath the screen title heading. Rotate the data entry control to select another screen.

To modify a parameter

Press the either of the cursor keys repeatedly (or hold the right cursor key while turning the data entry control) until the cursor is underneath the parameter value. Rotate the data entry control to change the value.

To return to Preset Select mode

Press the Master key, turning off the LED.

MASTER MENU FUNCTIONS

- ***Master Tune***

Master Tune adjusts the overall tuning of all presets so that Planet Phatt can be tuned to other instruments. The master tuning range is ± 1 semitone in 1/64th semitone increments. A master tune setting of "00" would indicate that Planet Phatt is perfectly tuned to concert pitch (A=440 Hz).



- **Transpose**

This function transposes the key of Planet Phatt in half-step intervals by shifting the keyboard position relative to middle C. The transpose range is ± 12 semitones or one octave.

TRANSCOPE
+12 semitones

- **Global Bend**

This function sets the range of the pitch wheel *only* when it is routed to control pitch. The maximum pitch bend range is ± 12 semitones. This function only affects presets which have their individual pitch bend range set to global.

GLOBAL BEND
+/- 12 semitones

- **Global Velocity Curve**

Incoming velocity data can be modified by a velocity curve in order to provide different types of dynamics in response to your playing or to better adapt to a MIDI controller. This function allows you to select one of eight global velocity curves or leave the velocity data unaltered (off). Global velocity curve only affects presets which have their individual velocity curve set to global.

GLOBAL VEL CURVE
8

GLOBAL VELOCITY CURVES

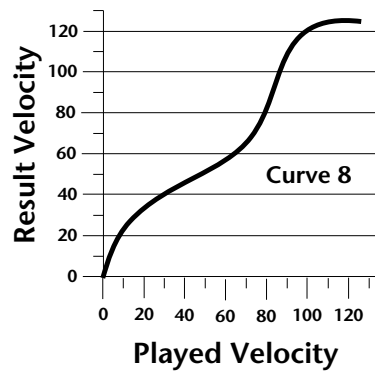
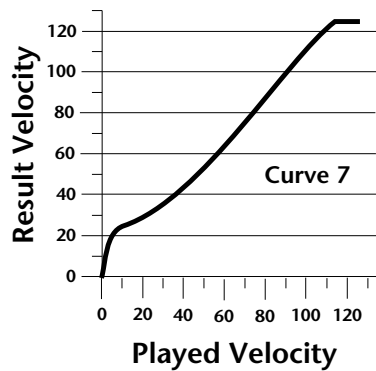
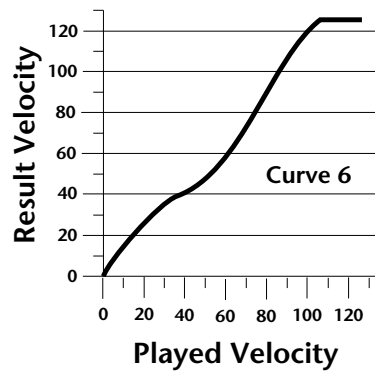
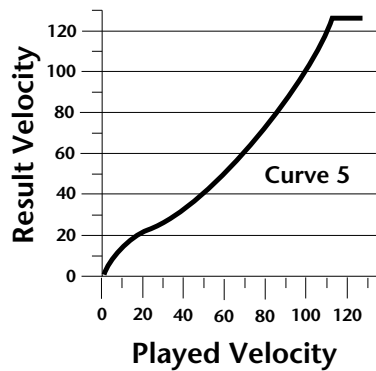
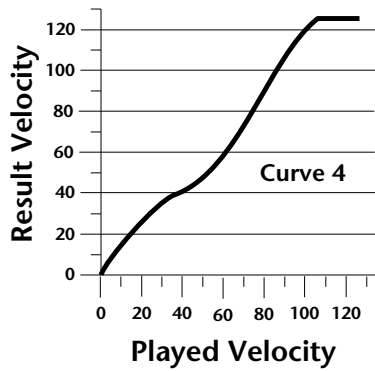
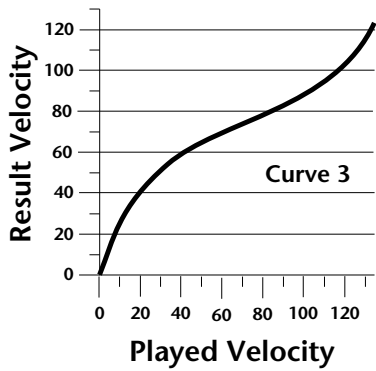
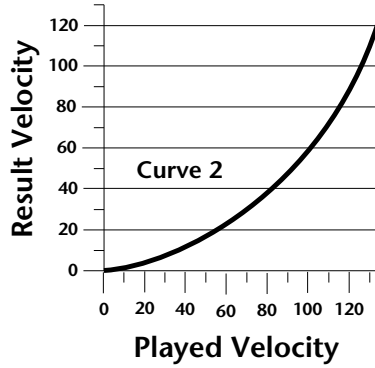
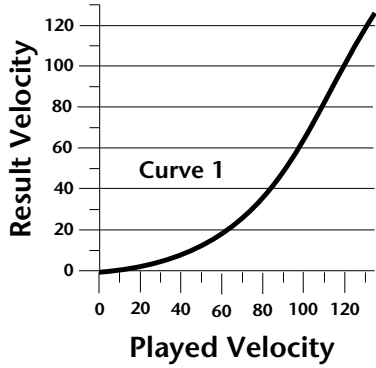

••• This function is useful when sequencing because it allows you route specific MIDI channels to the Submix outputs. From there they can be externally processed with reverb or other effects.

• **Mix Output**

This function allows you to override the output assignments made in each preset and instead assign the outputs according to MIDI channel. This also allows you to change the output assignment of the factory presets. For each of the 16 MIDI channels, you can select the Main, Sub 1, or Sub 2 outputs, or "P". When "P" is selected, the output assignment selected in the preset is used. If no plugs are inserted into the sub outputs, the audio will be automatically directed to the main outputs.

MIX OUTPUT channel 01:P

• **MIDI Mode**

This function selects one of the four MIDI modes and the MIDI system exclusive ID number.

Omni mode

Planet Phatt responds to note information on all MIDI channels and plays the preset currently displayed in the main screen.

Poly mode

Planet Phatt only responds to note information received on the currently selected MIDI channel (on the preset selection screen) and plays that channel's associated preset.

Multi mode

Planet Phatt responds to data on any combination of MIDI channels and plays the specific preset associated with each of the MIDI channels.

Mono mode

Planet Phatt responds to data on any combination of MIDI channels but plays each channel monophonically. If a new note on a channel is played before the last note is released, the envelopes will not be retriggered (legato).

ID number

This function allows a computer patch editor to distinguish between multiple Planet Phatt units. In the case of multiple Planet Phatt units, each unit should have a different ID number.

MIDI MODE	ID
Omni	00

▼ **Warning:** To transfer presets between two Planet Phatt units, the ID numbers of both units must match.

• **MIDI Mode Change**

This function selects whether or not MIDI mode change commands are accepted or ignored when received over MIDI (see MIDI Mode).

MIDI MODE CHANGE
Disabled

• **MIDI Overflow**

When on, if you play more notes than Planet Phatt has channels (32), the additional note data will be directed out the MIDI Out port to a second Planet Phatt, thus doubling the number of available channels. MIDI Overflow can be turned On or Off.

MIDI OVERFLOW
Off

• **MIDI Enable**

When in MIDI Multi mode, this function lets you turn each MIDI channel On or Off. This is useful when you have other MIDI devices connected and do not want the Planet Phatt to respond to the MIDI channels reserved for the other devices. MIDI Enable only operates in Multi Mode.

MIDI ENABLE
channel 01: On

• **MIDI Bank Select**

The MIDI specification only allows for 128 presets per MIDI channel. This function selects which bank of 128 presets will be used for incoming MIDI program change commands. Banks can be set for each MIDI channel. This function allows you to access all 640 presets in Planet Phatt without using a MIDI bank select command.

MIDI BANK
channel 01: 4 ← MIDI Preset Bank

↑
MIDI Channel

- **MIDI Program → Preset**

Incoming MIDI program changes can be “remapped” to call a different numbered preset. This is a handy feature when you want a specific preset number sent from the master synth to be linked with a specific preset on Planet Phatt. For example, the Program → Preset Map could be set to call up preset 12 whenever Planet Phatt receives program change number 26. Any of the presets in Planet Phatt can be mapped to any incoming MIDI program change number. This feature also allows you to select presets in banks 1-4, which are not normally accessible over MIDI without sending bank change commands.

Note: The MIDI Program->Preset Map only works when you are in Bank 0.

MIDI PROG>PRESET
026 -> 012⁰

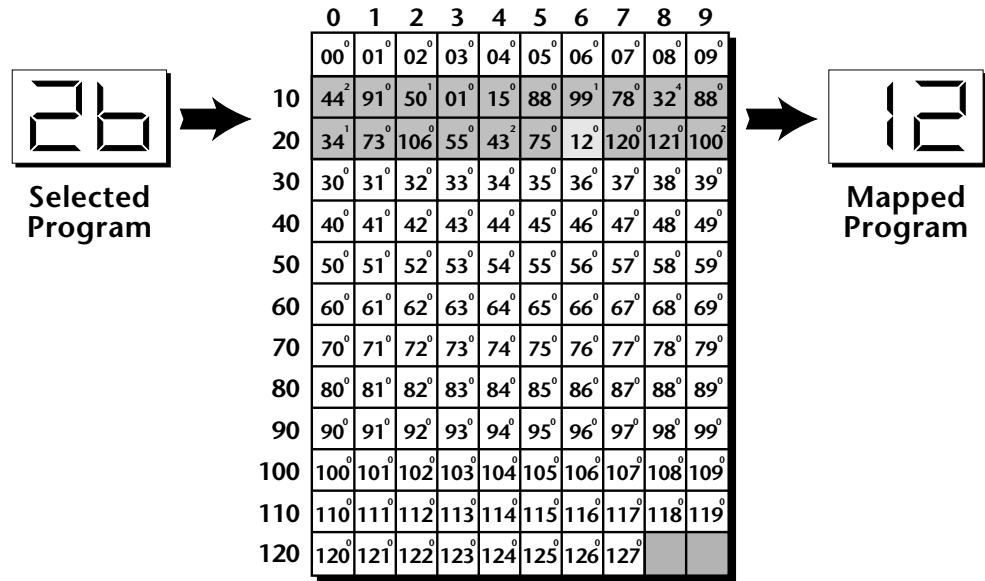

This chart shows how MIDI preset changes can be re-mapped. In this example, program changes 10-29 have been re-mapped. All other programs will be selected normally.

• **Preset Change**

This function lets the Planet Phatt utilize or ignore incoming MIDI preset change or Bank Select commands for each channel. Note that a MIDI program change command can only select presets in bank 0. The presets in banks 1-4 can be selected manually, by changing the MIDI bank, by using a MIDI bank select command, or by using the mapping function “MIDI PROGRAM → PRESET”.

```
PRESET CHANGE
channel 01: On
```

• **MIDI Controller Assign**

Planet Phatt allows you to assign up to four realtime control sources from your MIDI controller. These control sources could be modulation wheels, data sliders or whatever. **In this screen, you set up which controllers will be received by Planet Phatt.** What effect the controller will have is programmed separately for each preset. Planet Phatt MIDI controllers are each assigned a letter, A-D. Each controller letter can be assigned to a MIDI realtime controller from 00-31. **Note:** If controller numbers 7 or 10 are selected, they will override the standard MIDI volume and pan control routings.

```
CONTROLLER# ABCD
01 02 03 04
```

• **X Factor Control**

This function allows any MIDI controller number from 0-31, mono pressure, or the pitch wheel to change the X Factor (transpose) of Beats mode. Two controllers can be assigned to move the X Factor both up and down from its initial position. With a wheel assigned to the up control, moving the wheel up adds a positive offset to the X Factor setting. Moving the wheel back down returns the X Factor to its original setting. The maximum controller offset is ± 36 , which is added to the initial setting. The pitch wheel (pwh) can be assigned to both up and down settings to allow bidirectional control. When “Off” is selected, external control of X Factor is disabled. This controller is only recognized on MIDI channel 16, unless Planet Phatt is in Omni mode, in which case all channels are accepted.

```
X FACTOR CONTROL
up:14   down:15
```

••• **A few of the standardized MIDI Controller numbers are listed below.**

- 1 - Modulation Wheel
- 2 - Breath Controller
- 3 - Aftertouch
- 4 - Foot Pedal
- 5 - Portamento Time
- 6 - Data Entry
- 7 - Volume
- 8 - Balance
- 9 - Undefined
- 10 - Pan
- 11 - Expression

••• For more information on controller assignments, see *MIDI Realtime Controls in the Programming Basics* section.

••• The X Factor, Tempo Control Retrigger and Scratch settings are sent and received with the Master Settings. See **Send MIDI Data**.

••• When X Factor Control is being used, the last setting of the MIDI controller remains in effect when a new Beat is selected.

••• When Tempo Control is being used, the last setting of the MIDI controller remains in effect when a new Beat is selected.

▼ When the Global Tempo is set to "External", the Tempo Control parameter will not have any effect.

••• When a MIDI controller is used to control Retrigger, the last setting of the MIDI controller remains in effect when a new Preset or Beat is selected.

▼ When the Global Tempo is set to "External", the 1/64th note divisor is not possible. 1/64 T will be substituted, even though the display reads 1/64.

• Tempo Control

This function allows MIDI controllers to change the Global Tempo which is used for Beats mode, Retrigger, and the synced LFOs. Any controller number from 0-31, mono pressure, or the pitch wheel can be assigned to change the Global Tempo. A different controller can be used to change the tempo up or down. The Pitch Wheel can be assigned to both the up and down parameters to vary the tempo up and down from a single controller. MIDI Controller values are added to the Global Tempo with an offset range of ± 64 . When the controller is set to zero (off) the tempo returns to its original setting. This controller is only recognized on MIDI channel 16, unless Planet Phatt is in Omni mode, in which case all channels are accepted. This control has no effect when External Clock is being used.

TEMPO CONTROL
up:pwh down:pwh

• Retrigger

The Retrigger function creates a "stuttering" effect by resetting the sample start point and envelope generators to their starting point every time a trigger is received. The rate of retriggering is based on the Global Tempo which is divided down by the Retrigger Rate parameter. A MIDI continuous controller (0-31 or Mono Pressure) can also be assigned to control the Global Tempo divisor. Set the rate parameter to "Off" to disable retriggering.

RETRIGGER
ch:01 rate:1/16

The following Retrigger divisors are available:

Db1	- Double Whole Notes	1/8	- Eighth Notes
Db1 T	- Double Whole Note Triplets	1/8 T	- Eighth Note Triplets
Whole	- Whole Notes	1/16	- Sixteenth Notes
Wh1 T	- Whole Note Triplets	1/16 T	- Sixteenth Note Triplets
Half	- Half Notes	1/32	- Thirty-second Notes
Half T	- Half Note Triplets	1/32 T	- Thirty-second Note Triplets
1/4	- Quarter Notes	1/64	- Sixty-fourth Notes
1/4 T	- Quarter Note Triplets	1/64 T	- Sixty-fourth Note Triplets

• **Pitch Wheel -> Scratch**

This function allows the pitch wheel to simulate record scratching. When this function is On, the speed that you move the pitch wheel back and forth determines the pitch of the keys being played. Therefore the faster you move the wheel back and forth, the faster the sound plays through. The amount of control the wheel has is adjustable from 1 to 100. Adjust the amount depending on the type of sound being scratched and to suit your personal preference. Scratch can be assigned to any MIDI channel from 1-16 or to “All” channels. Setting the channel to “None” turns scratch mode off.

PITCH WH->SCRATCH ch:01 amt:50
--

• **MIDI Footswitch Assign**

Like the MIDI Controllers, 3 MIDI footswitches can be assigned to MIDI footswitch numbers. Footswitches can be assigned numbers from 64-79. Destinations for the footswitch controllers are programmed in the Edit menu.

FOOTSWITCH # 1:64 2:65 3:66

••• **A few of the standardized MIDI switch numbers are listed below.**

- 64 - Sustain Switch (on/off)
- 65 - Portamento (on/off)
- 66 - Sostenuto (on/off)
- 67 - Soft Pedal (on/off)
- 69 - Hold Pedal 2 (on/off)

••• The Preset, Volume, and Pan information for all 16 channels is included when the Master settings are transmitted or received.

▼ **Warning:** When transferring SysEx data from one Planet Phatt to another, the ID numbers of both units must match.

• **Send MIDI Data**

This function will send MIDI System Exclusive data to the MIDI Out port of Planet Phatt. The MIDI data can either be sent to a computer/sequencer or to another Planet Phatt. Using the cursor key and the data entry control, select the type of MIDI data you wish to transmit.

User Beat Data

Transmits all User Beat data (tempos, X factor, preset) and all user Song Beat data (events, repeats, jumps).

Master Settings

Transmits all parameters in the Master menu except tuning table, program/preset map and viewing angle.

Program/ Preset Map

Transmits only the program/preset map.

Tuning Table

Transmits only the user tuning table.

Factory Presets

Transmits all the factory ROM presets.

User Presets

Transmits all the user presets.

Any Individual Preset

Transmits only the selected preset.

The Enter LED will be flashing. Press the Enter button to confirm the operation. To receive MIDI data, simply send the MIDI data into Planet Phatt from another Planet Phatt or your sequencer.

SEND MIDI DATA
000 sbs:1st Bass

To Record MIDI Data into a Sequencer:

1. Setup sequencer to receive system exclusive data.
2. Place sequencer into record mode, then Send Preset Data.

To Receive MIDI Data from a Sequencer:

1. Simply play back the sequence into Planet Phatt.

▼ **Warning:** Send data as you would a regular sequence. Sending data in one huge chunk may clog Planet Phatt's MIDI input buffer.

• **Beats MIDI Out**

This function allows Beat note and controller data to be sent out MIDI as the Beats are playing. Selecting “Transmit” sends the MIDI data as the beats play. Selecting “Transmit & Mute” sends the data over MIDI data but does not play internal voices.



• **User Key Tuning**

In addition to standard twelve tone equal temperament, Planet Phatt contains four additional preset tuning tables (Just C, Vallotti, 19 tone, and Gamelan) and one user definable tuning. User Key Tuning allows you to alter the parameters of the user definable tuning. The pitch of every key can be individually tuned, facilitating the creation of alternate scales. Using the cursor key and the data entry control, select the key name, the MIDI key number and the fine tuning. The key name is variable from C-2 to G8. MIDI key number is variable from 0 to 127. The fine tuning is variable from 00 to 63 in increments of 1/64 of a semitone (approx. 1.56 cents). For each preset, the specific tuning table is selected in the Edit menu.

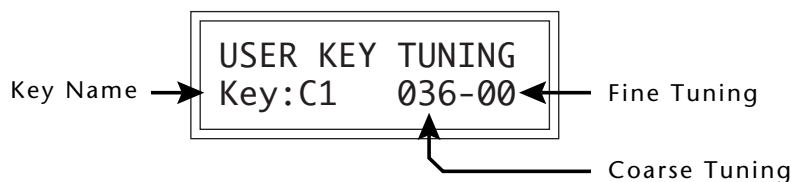

• **Song Start/Stop**

This function enables or disables MIDI Song Start/Stop for Beats mode. In some cases you may want to start Beats mode along with an external sequencer. In other cases you may want to start Beats mode independently. This control allows you either option. Song Select or MIDI clocks are not affected by this function. You can also use the Beats Control number (*see the following page*) to control Song Start/Stop even when this function is disabled.



••• *The Beats MIDI Out settings are sent and received with the Master Settings. See **Send MIDI Data**.*

••• **Application:** *The user key tuning can be used to tune individual percussion instruments.*

▼ When the Global Tempo is set to "External", the Tempo Control parameter will not have any effect.

• Global Tempo

This function sets the tempo for Beats mode, Synced LFOs and the Retrigger features. This tempo setting is the same as shown in Beats mode and any changes you make will be shown in either window. The global tempo is variable from 1 beats-per-minute (bpm) to 255 bpm. Turning the tempo down below 1 bpm sets the tempo to "External" mode. In external mode, the tempo is determined by incoming MIDI clocks and Beats mode will not start if there is no incoming MIDI clock to set the tempo.

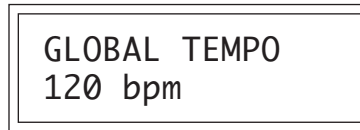

• Beats Control

This function allows you to control Beats mode using standard MIDI Note-on messages. The selectable options are: "Mute Key", "Start Key", and "Stop Key". The Mute Key, while pressed, silences the beat or song without stopping it and also silences MIDI transmission of beats. Any MIDI key number can be assigned to the three controls, but they must be received on MIDI channel 16 to be recognized unless Planet Phatt is in Omni mode, in which case all channels are accepted. *These keys only work when the beats screen is displayed.*

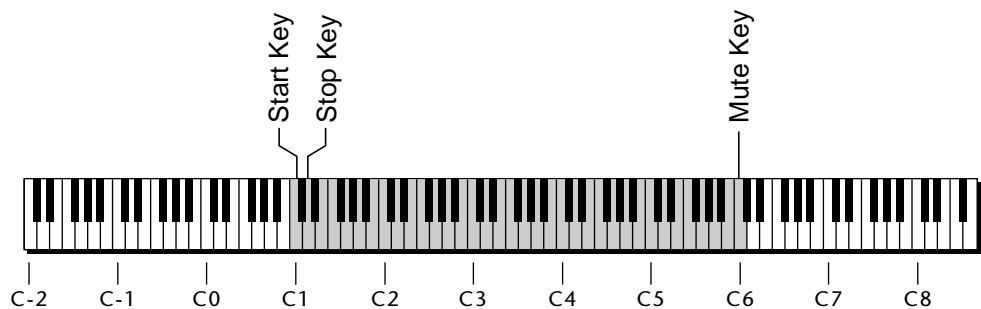

 = Standard 5 Octave Keyboard Range

Control keys can be placed out of the way at the ends of the keyboard or anywhere you prefer.

• **Beats Mode**

There are four options when in Beats mode: Factory Settings, Constant Tempo, Constant T, X, P and User Settings. These modes affect the way Planet Phatt responds to parameter changes in Beats Mode. The characteristics of each mode are detailed below.

Factory Settings The Tempo, X Factor (transpose) and Preset are preset at the factory. These can be changed, but any changes are lost when the beat number is changed.

1:Constant Tempo The Factory settings of Preset and X Factor will be used whenever a new beat is selected, but the Tempo can be user-adjusted and will remain constant when new beats are selected.

2:Constant T, X, P Tempo, X Factor and Preset are user-adjustable and will remain constant when new beats are selected.

3:User Settings All Beat parameters (Tempo, X-Factor, Preset) are user-adjustable and are immediately saved to non-volatile RAM. These user settings remain stored in RAM even if another Beats mode (such as factory settings) has been selected.



• **Demo Sequence**

Planet Phatt contains a play-only demo sequencer to give you an idea of what is possible using this Phantastic machine. Press either cursor key to move the cursor to the lower line of the display and press Enter. The Demo Select screen will appear and the first sequence will begin playing. All four sequences will play in sequential order. Use the cursor keys to select a particular sequence. Pressing the Enter button again will stop the sequence and return you to the first Demo screen.

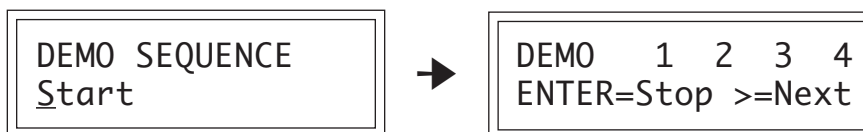

- ***Viewing Angle***

This function allows you to change the viewing angle of the display so that it may be easily read from either above or below. The angle is adjustable from +7 to -8. Positive values will make the display easier to read when viewed from above. Negative values make the display easier to read from below.

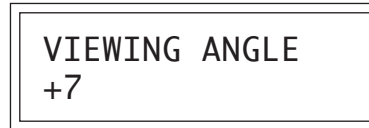

PROGRAMMING BASICS

This chapter explains how sounds are constructed on Planet Phatt and contains important background information on how to create your own custom presets.

Your initial involvement with Planet Phatt will most likely consist of using the existing presets and selecting MIDI channels. While the factory presets are very good, there are probably some things you would like to change, perhaps the LFO speed, the filter cutoff or the attack time. You may also want to make your own custom presets using complex modulation routings. There are 256 user locations (Banks 0 & 1) available to store your own creations or edited factory presets. Best of all, it's easy to edit or create new presets using the edit menu.

Presets can be made up of both a primary and secondary instrument. Presets can also be "linked" with up to 3 additional presets to create layering or splits.

One way to create a keyboard split is assign an instrument to a specific range and then link it to other presets which fill in the empty keys. Using a combination of 4 linked presets and the primary and secondary instrument ranges, up to 8 keyboard splits can be produced. If linked presets overlap on the same keyboard range, the presets will be doubled or stacked.

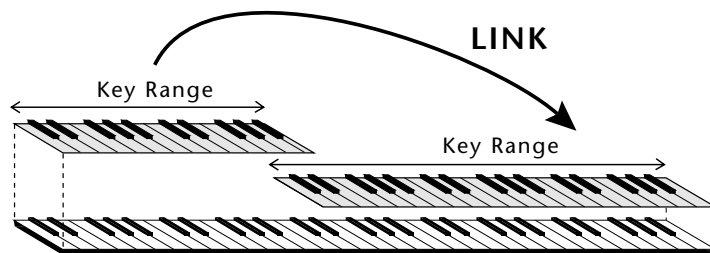

CREATING A SPLIT KEYBOARD



LAYERING TWO PRESETS

These diagrams show how keyboard splits and layers can be created by linking presets. Remember that each preset can consist of both a primary and secondary instrument.

Planet Phatt has an extensive modulation implementation using two multi-wave LFO's (Low Frequency Oscillators), two envelope generators and the ability to respond to multiple MIDI controllers. You can simultaneously route any combination of these control sources to multiple destinations.

MODULATION

Modulation means to *dynamically change* a parameter, whether it be the volume (amplitude modulation), the pitch (frequency modulation), or whatever. Turning the volume control on your home stereo rapidly back and forth would be an example of amplitude modulation. To modulate something we need a modulation *source* and a modulation *destination*. The source is your hand turning the knob, and the destination is the volume control. If we had a device that would automatically turn the volume control, we would also call that device a modulation source. The Planet Phatt is designed so that for each of the variable parameters, such as the volume, there is an initial setting which can be changed by a modulation source. Therefore in the case of volume, we have an initial volume and we can change or modulate that volume with a modulation source. Two main types of modulation sources on Planet Phatt are *Envelope Generators* and *Low Frequency Oscillators*. In the example above, an envelope generator could be routed to automatically turn the volume control as programmed by the envelope. Or, a low frequency oscillator could be routed to automatically turn the volume control up and down in a repeating fashion.

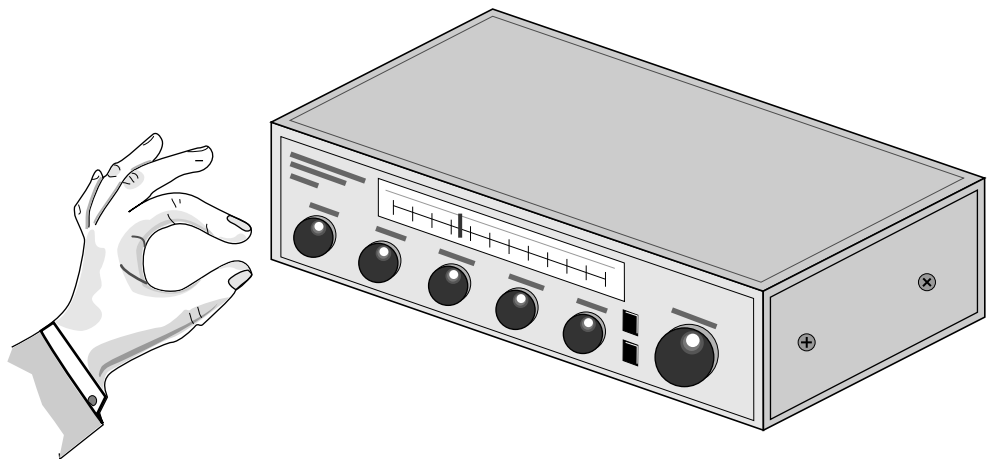

Turning the volume control back and forth on your home stereo is an example of Amplitude Modulation.

MODULATION SOURCES

Planet Phatt uses three kinds of modulation sources.

- **KEYBOARD AND VELOCITY MODULATION**

Values which are generated at the start of a note and do not change during the note.

Keyboard Key

Which key is pressed.

Key Velocity

How hard the key is pressed.

- **REALTIME MODULATION**

Values which can be continuously changed during the entire duration of the sound.

Pitch Wheel

A synthesizer pitch bend wheel.

Miscellaneous Controllers (4)

Any type of MIDI controller data.

Keyboard Pressure (mono aftertouch)

Key pressure applied after the key is initially pressed.

Polyphonic Key Pressure

Pressure from a controller capable of generating polyphonic pressure data.

Low Frequency Oscillators (2)

Generate repeating waves.

Envelope Generators (3)

Generate a programmable “contour” which changes over time when a key is pressed.

- **FOOTSWITCH MODULATION**

Changes a parameter when one of the three footswitches are pressed. The footswitches can be programmed to switch: Sustain (pri/sec/both), Alternate Volume Envelope (pri/sec/both), Alternate Volume Release (pri/sec/both), or Cross-Switch between the primary and secondary instruments.

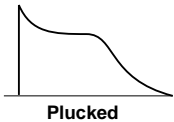
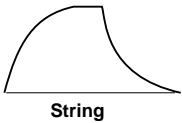
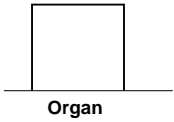
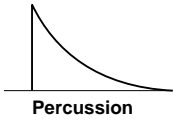

••• The generalized envelope shapes of a few types of sounds are shown above.

••• Long release times can increase the incidence of "channel ripoff". If you are running out of voice channels, try reducing the volume envelope release time.

ENVELOPE GENERATORS

An envelope can be described as a "contour" which can be used to shape the sound in some way over time. Each channel of the Planet Phatt contains two envelope generators. One of the envelope generators, the Alternate Volume Envelope, controls the volume of the primary or secondary instrument over time and has 5 stages, Attack, Hold, Decay, Sustain, and Release. The other envelope, the Auxiliary Envelope, can be routed to any realtime control destination and is a general purpose envelope. The Auxiliary Envelope has 6 stages: Delay, Attack, Hold, Decay, Sustain, and Release. The time of each stage can be adjusted to create myriad envelope shapes, which in turn shape the sound. The Envelope parameters can be described as follows:

- **Delay**
The time between when a key is played and when the attack phase begins.
- **Attack**
The time it takes to go from zero to the peak (full) level.
- **Hold**
The time the envelope will stay at the peak level before starting the decay phase.
- **Decay**
The time it takes the envelope to go from the peak level to the sustain level.
- **Sustain**
The level at which the envelope remains as long as a key is held down.
- **Release**
The time it takes the envelope to fall to the zero level after the key is released.

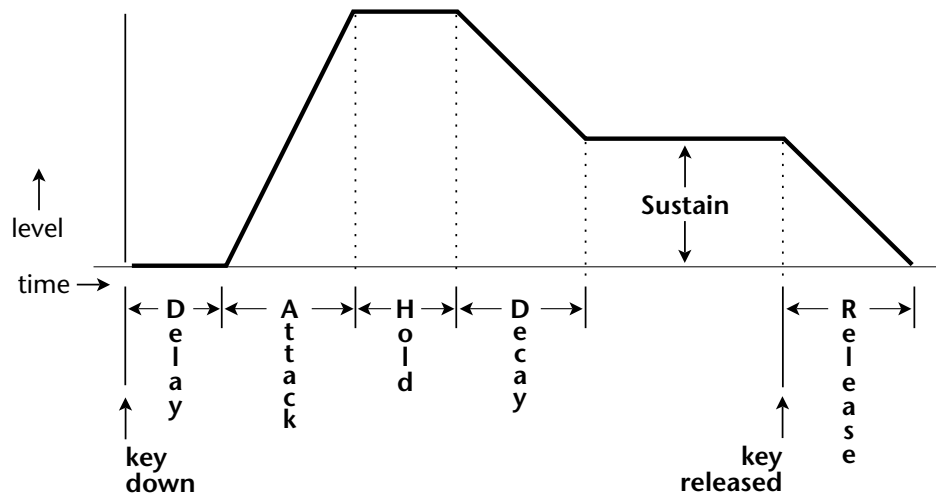

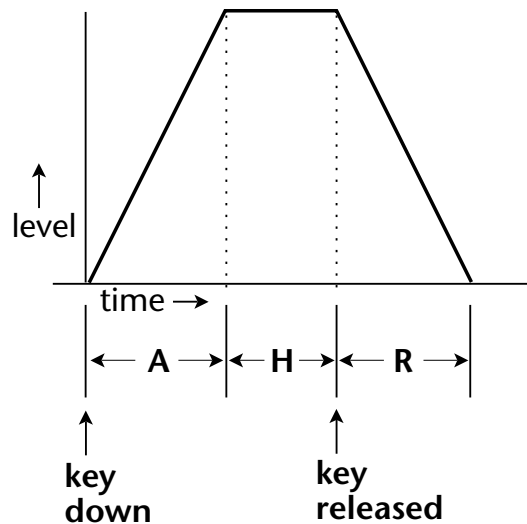

If the key is released during the Hold (H) phase, the Release phase begins.

LOW FREQUENCY OSCILLATORS (LFOs)

A Low Frequency Oscillator is simply a wave which repeats at a slow rate. The Planet Phatt has two multi-wave LFOs for each of its 32 channels. The LFO waveforms are: Triangle, Sine, Square, Sawtooth, and Random, which is a random “sample and hold” type of wave. Other LFO waves are “Synced” which means that their rates will follow the tempo as set in Beats mode.

By examining the diagram of the LFO waveforms, you can see how the LFO will affect a modulation destination. Suppose we are modulating the pitch of an instrument. The sine wave looks smooth, and will smoothly change the pitch. The square wave changes abruptly, and will abruptly change the pitch from one pitch to another. The sawtooth wave smoothly decreases, then abruptly changes back up. The sound’s pitch will follow the same course. Controlling the pitch of an instrument is an easy way to hear the effects of the LFO waves.

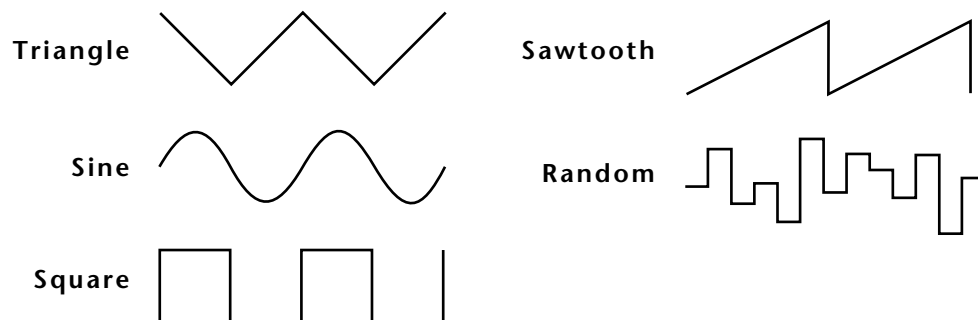

When the amount of an LFO is a negative value, the LFO shape will be inverted. For example, inverting the sawtooth wave produces a wave that smoothly increases, then instantly resets down.

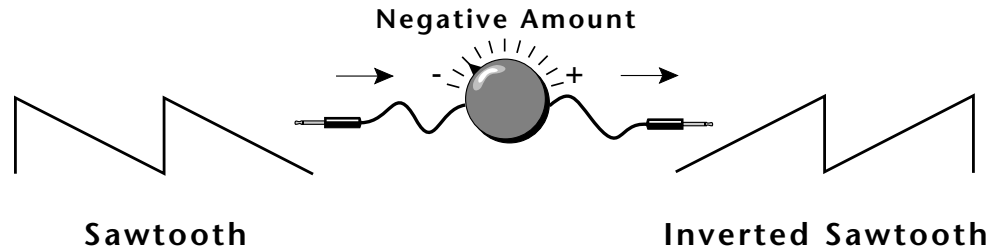

The LFO can also be **Synced** the tempo programmed in the beats menu. When synced, the LFO rate will increase or decrease to follow the beats/global tempo.

MIDIPATCH

Connecting a modulation source to a destination is called a *patch*. Planet Phatt lets you connect the modulation sources in almost any possible way to the modulation destinations. You can even modulate other modulators. Each patch also has an amount parameter which determines “how much” modulation is applied to the destination. The modulation amount can be positive or negative and will either add or subtract from the initial value. Keyboard and velocity sources can be simultaneously patched to any 6 of the 42 destinations for each preset. Realtime modulation sources can be simultaneously patched to any 8 of the 33 destinations for each preset.

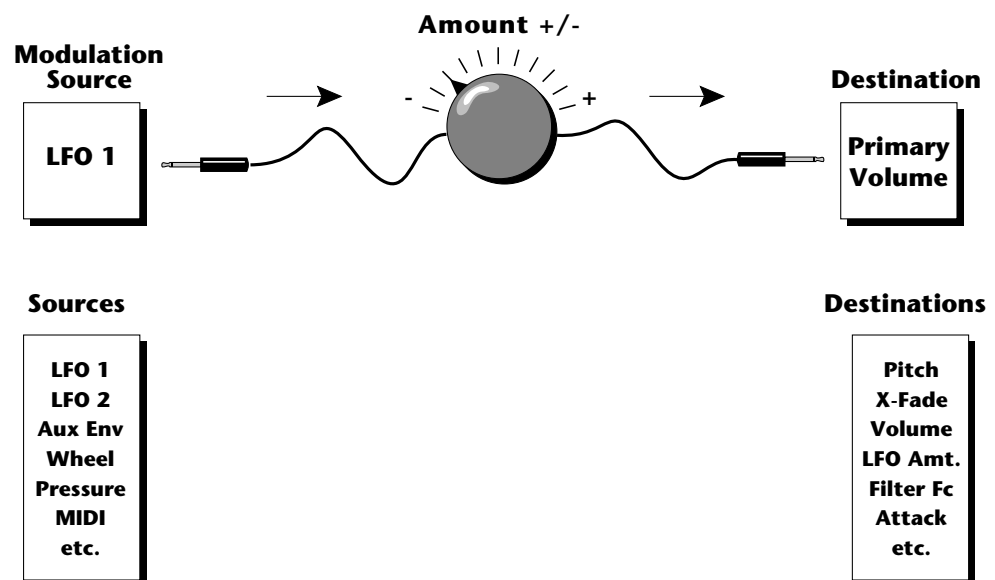

FILTER MODULATION

Planet Phatt contains a Z-plane filter for each of its 32 channels. The block diagram of a single channel is shown below.

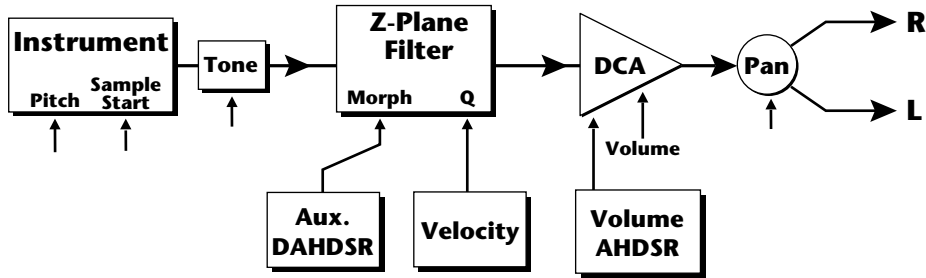

The **Tone** filter is a simple tone control and can be used to brighten or darken the tone of an instrument. Each of the 17 Z-plane filters is a powerful synthesizer filter which can dramatically alter the sound of an instrument.

WHAT IS A FILTER?

To understand how a filter works we need to understand what makes up a sound wave. A sine wave is the simplest form of sound wave. Any waveform except a sine wave can be analyzed as a mix of sine waves at specific frequencies and amplitudes.

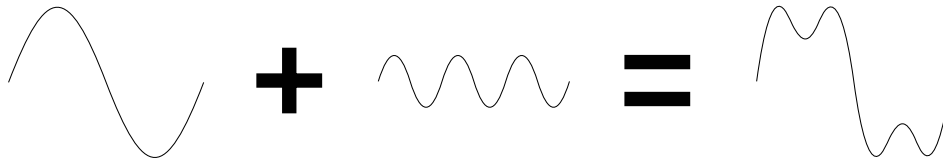

One way to represent complex waveforms is to use a chart with frequency on one axis and amplitude on the other. Each vertical line of the chart represents one sine wave at a specific amplitude.

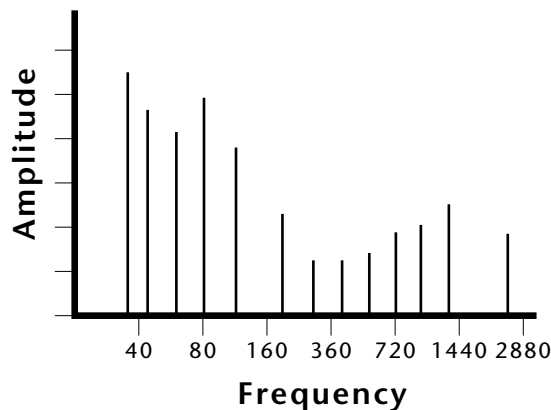

••• The initial filter F_c and all F_c modulators ADD algebraically to determine the actual F_c . If you are not getting sound, adjust the initial F_c or reduce the amount of modulation. Careful adjustment of all the filter parameters is the secret to getting great sounds.

Most of the instruments on Planet Phatt are complex waves containing many sine waves of various amplitudes and frequencies. A **filter is a device which allows us to remove certain components of a sound depending on its frequency**. For example, a Low Pass Filter, one of the Z-plane filter types in Planet Phatt, lets the *low frequencies pass* and removes only the high frequencies.

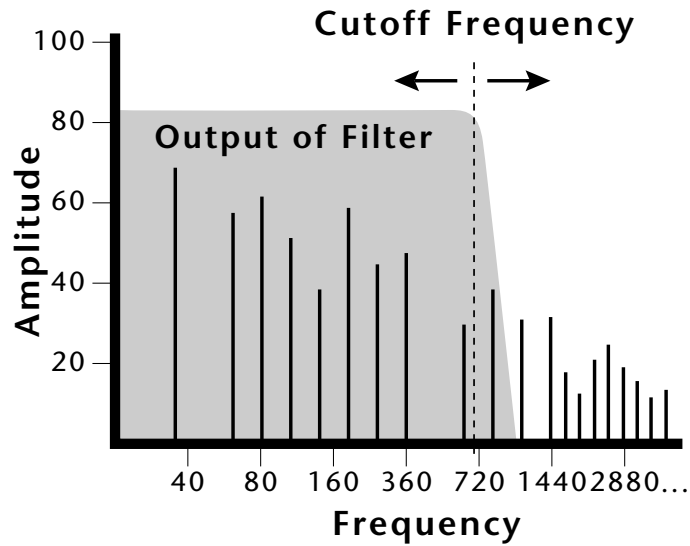

The point at which the frequencies begin to be cut is called the **Cutoff Frequency** (or F_c for short). A filter that let only the high frequencies pass would be called a High Pass filter. Using a filter, we now have a way to control the harmonic content of a sampled sound. As it turns out, a low pass filter can simulate the response of many natural sounds.

For example, when a piano string is struck by its hammer, there are initially a lot of high frequencies present. If the same note is played softer, there will be fewer of the high frequencies generated by the string. We can simulate this effect by routing the velocity of the keyboard to control the amount of high frequencies that the low pass filter lets through. The result is expressive, natural control over the sound.

The auxiliary envelope generator is commonly used to control the cutoff frequency of the Z-plane filter. This allows the frequency content to be varied dynamically over the course of the note. Dynamic filtering coupled with all the different instruments available, makes for almost endless possibilities in the final sound. Any modulation source can be used to modulate the filter.

Another control on the filter is called Q or resonance. On a lowpass or highpass filter, turning up the Q of the filter emphasizes the frequencies around the cutoff frequency. The chart below shows how different amounts of Q affect the lowpass filter response. In terms of sound, frequencies around the cutoff will tend to “ring” with high Q settings. If the filter is swept back and forth slowly with a high Q, various overtones will be “picked out” of the sound and amplified as the resonant peak sweeps over them. Bells and gongs are real world examples of sounds which have a high Q.

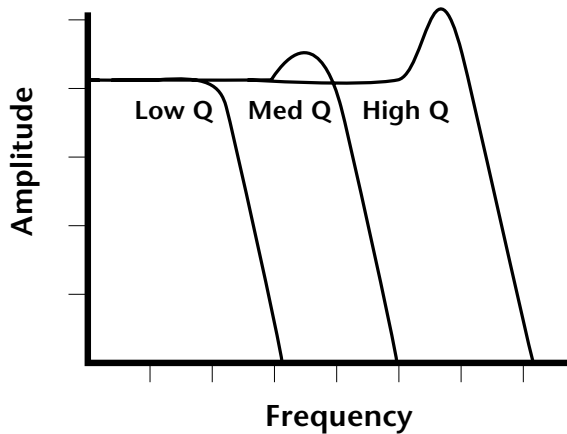

Turning up the “Q” will emphasize the frequencies around the cutoff point.

Another important feature of a filter is the number of poles it contains. The lowpass filters on Planet Phatt can be either 2-pole, 4-pole or 6-pole filters. The highpass and bandpass filters can be either 2nd or 4th order filters another way to describe the number of filter sections they contain. The number of poles in a filter describes the steepness of its slope and the more poles the steeper the slope, which in turn affects the sound. In general, the 2-pole filter will have a buzzy sound and the 4-pole filter has the classic low pass resonant filter sound. Planet Phatt's 6-pole low pass filters create a tight, modern sound.

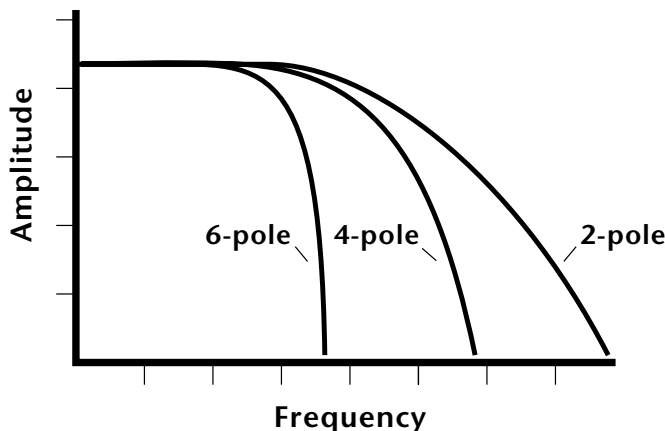

PARAMETRIC FILTERS

A more complex type of filter is called a parametric filter or Swept EQ. A parametric filter allows control over three basic *parameters* of the filter. The three parameters are: *Frequency*, *Bandwidth*, and *Boost/Cut*. The Frequency parameter (F_c on Planet Phatt filters) allows you to select a range of frequencies to be boosted or cut, the Bandwidth parameter allows you to select the width of the range, and the Boost/Cut parameter (Q on Planet Phatt filters) either boosts or cuts the frequencies within the selected band by a specified amount. Frequencies not included in the selected band are left unaltered. This is different from a band pass filter which attenuates (reduces) frequencies outside the selected band.

The parametric filter is quite flexible. Any range of frequencies can be either amplified or attenuated. Often times, several parametric sections are cascaded (placed one after another) in order to create complex filter response curves.

THE Z-PLANE FILTER

The Z-plane filter can change its function over time. In a simple Z-plane filter, we start with two complex filter types and interpolate between them using a single parameter. Refer to the diagram below.

Filters A and B represent two different complex filters. By changing a single parameter, the *Morph*, many complex filter parameters can now be changed simultaneously. Following along the Morph axis you can see that the filter response smoothly interpolates between the two filters.

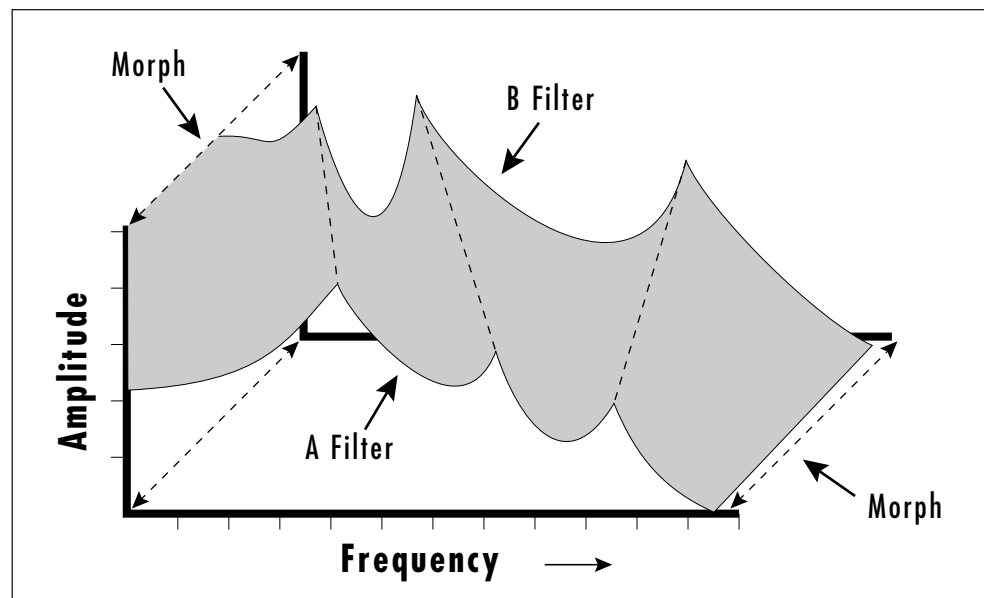

The Z-plane filter has the unique ability to change its function over time.

This is the essence of the Z-plane filter. Through the use of interpolation, many complex parameters are condensed down into one manageable entity.

Consider, as an example, the human vocal tract, which is a type of complex filter or resonator. There are dozens of different muscles controlling the shape of the vocal tract. When speaking, however, we don't think of the muscles, we just remember how it feels to form the vowels. A vowel is really a configuration of many muscles, but we consider it a single object. In changing from one vowel to another, you don't need to consider the frequencies of the resonant peaks! You remember the shape of your mouth for each sound and *interpolate* between them.

Filter morphing can be controlled by an envelope generator, an LFO, modulation wheels or pedals, keyboard velocity, key pressure, etc. The filter Fc parameter controls morphing on certain Planet Phatt filters. The Q parameter on the Planet Phatt filters can only be changed at note-on time but can control various parameters such as boost/cut and mouth cavity size and of course, resonance or Q.

PLANET PHATT SIGNAL FLOW

Going back to the block diagram for a single channel we can re-examine the complete signal path.

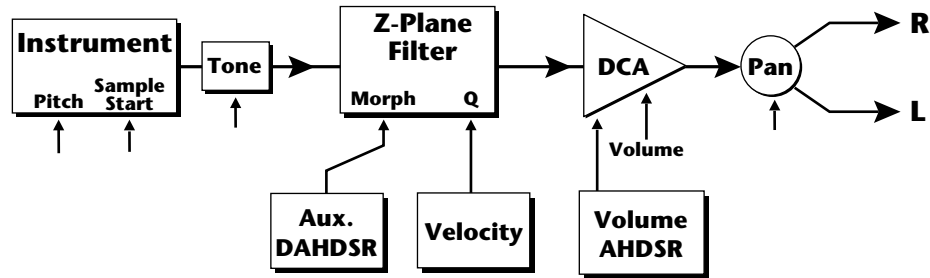

Instrument

This is the sampled sound wave. The pitch of the instrument can be modulated by any modulation source. The sample start point can only be modulated by a velocity or key source (*see the next page*).

Tone

Tone is a simple tone control which can be used to brighten or mute the sound. Tone can only be modulated by a velocity or key source (*see the next page*). Key velocity is commonly used to modulate the tone so that the harder you play, the brighter the sound becomes.

Morphing Filter

The Morphing Filter is used to shape the harmonic content of an instrument. The Fc can be modulated by any source. The auxiliary envelope is commonly used to dynamically shape the harmonic content over time. The Q parameter can only be modulated by a velocity or key source. There are 17 types of filters available. See page 67 for complete descriptions of each filter type.

DCA

Digitally **C**ontrolled **A**mplifier. Together with the Volume AHDSR, the DCA is used to shape the volume contour of a sound. The DCA can be controlled by any modulation source. Key Velocity is often used as a modulation source for the DCA so that the harder you play, the louder the sound becomes.

Pan

Adjusts the balance of sound to the left and right channels. Pan can be modulated by any realtime or note-on modulation source.

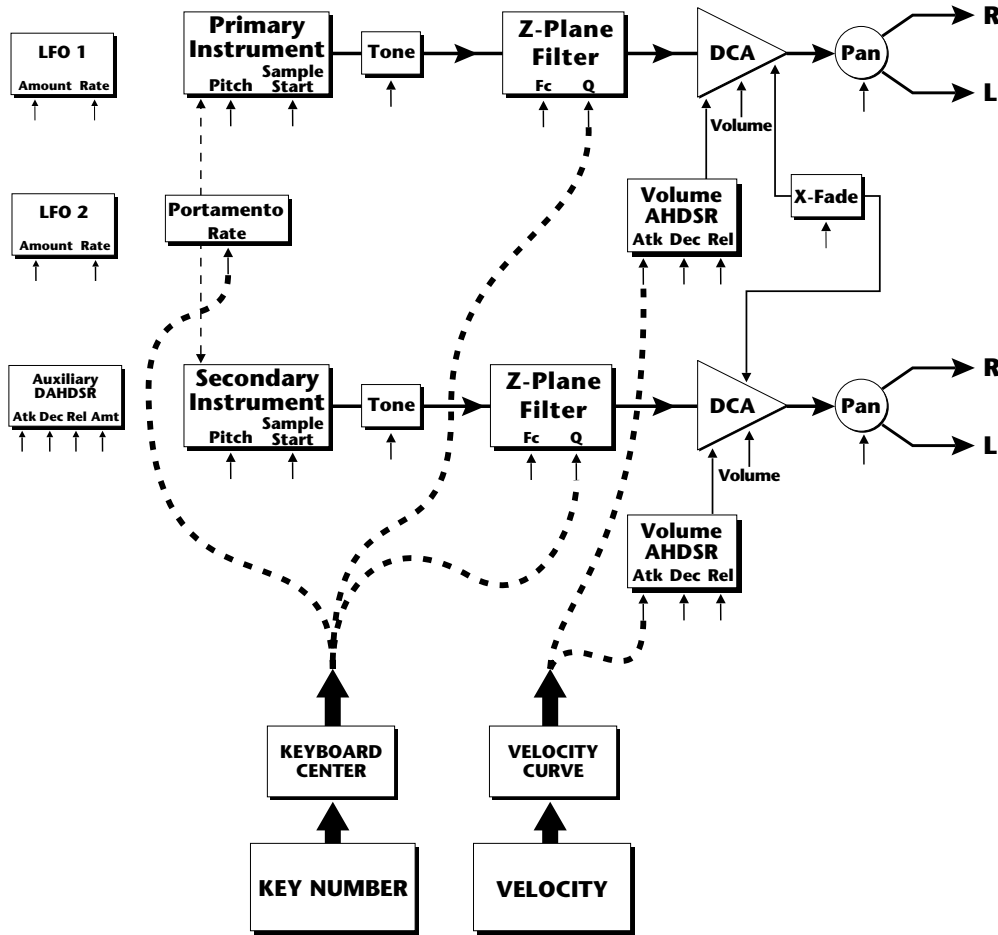

Keyboard and Velocity Modulation Sources

Keyboard Modulation Sources
 Key Number, Key Velocity

Destinations
 Off, Pitch, Primary Pitch, Secondary Pitch, Volume, Primary Volume, Secondary Volume, Attack, Primary Attack, Secondary Attack, Decay, Primary Decay, Secondary Decay, Release, Primary Release, Secondary Release, Crossfade, LFO 1 Amount, LFO 1 Rate, LFO 2 Amount, LFO 2 Rate, Auxiliary Envelope Amount, Auxiliary Envelope Attack, Auxiliary Envelope Decay, Auxiliary Envelope Release, Portamento Rate, Primary Portamento Rate, Secondary Portamento Rate, Filter Fc, Primary Filter Fc, Secondary Filter Fc, Filter Q, Primary Filter Q, Secondary Filter Q, Sample Start, Primary Sample Start, Secondary Sample Start, Pan, Primary Pan, Secondary Pan, Tone, Primary Tone, Secondary Tone

KEYBOARD AND VELOCITY MODULATION

The Keyboard and Velocity Modulation diagram shows the possible routing of Key Number (which key is pressed), and Velocity (how hard the key is pressed). These modulation sources can control any of the destinations indicated by the small arrows. Up to six key and velocity modulation routings can be programmed for each preset. Keyboard and velocity modulation routings are completely flexible as shown in the example above.

KEY NUMBER

The Key Number is affected by the Keyboard Center parameter which can be set to any key from A-2 to G8. The keyboard center establishes a reference point for keyboard modulation; keys above this point will have a positive value, while keys below it will be negative. For example, if we wished to change the volume of an instrument using key number and the key center were set to middle C, the instrument would get progressively louder above middle C and progressively softer below middle C.

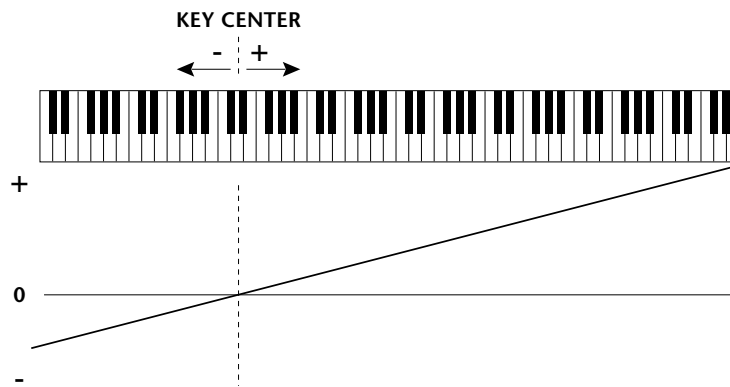

VELOCITY CURVES

Incoming velocity values can be scaled by one of the velocity curves in order to match your playing style or better adapt to the MIDI controller. Experiment with the curves to find the one that works best for your style and MIDI controller.

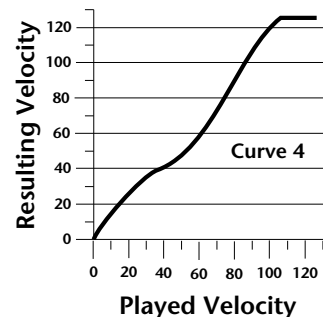
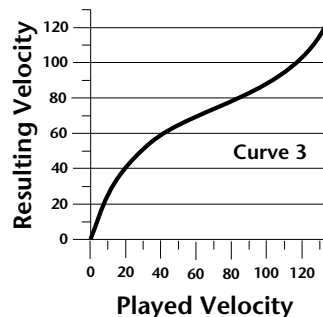
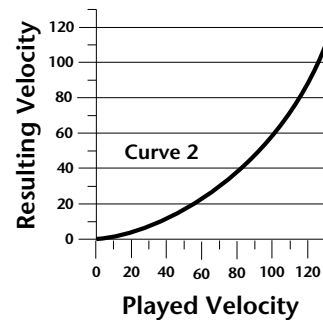
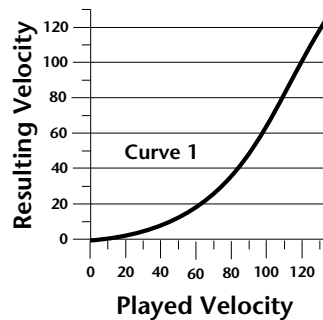

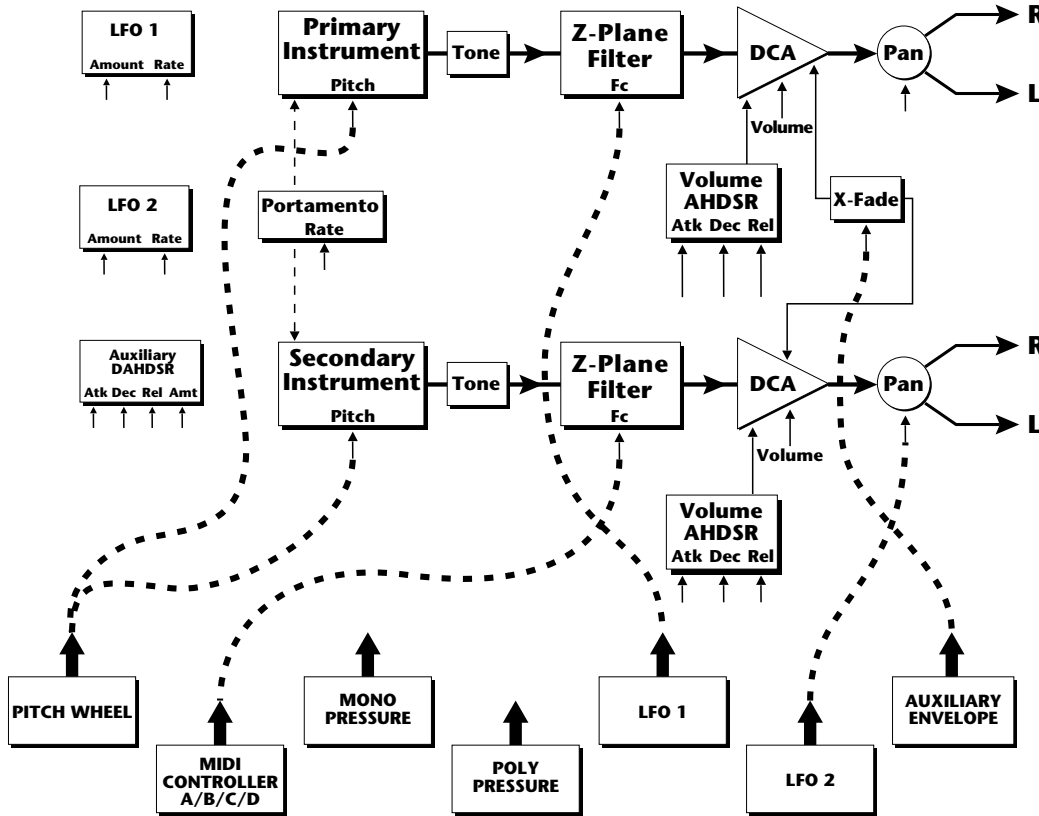

Realtime Modulation Sources

Realtime Modulation Sources

Pitch Wheel,
MIDI Control A,
MIDI Control B,
MIDI Control C,
MIDI Control D,
Mono Pressure,
Polyphonic Pressure,
LFO 1, LFO 2,
Auxiliary Envelope

Destinations

Off,
Pitch, Primary Pitch,
Secondary Pitch,
Volume, Primary Volume,
Secondary Volume,
Attack, Primary Attack,
Secondary Attack,
Decay, Primary Decay,
Secondary Decay,
Release, Primary Release,
Secondary Release,
Crossfade,
LFO 1 Amount, LFO 1 Rate,
LFO 2 Amount, LFO 2 Rate,
Auxiliary Envelope Amount,
Auxiliary Envelope Attack,
Auxiliary Envelope Decay,
Auxiliary Envelope Release,
Portamento Rate, Primary
Portamento Rate,
Secondary Portamento Rate,
Filter Fc, Primary Filter Fc,
Secondary Filter Fc,
Pan, Primary Pan,
Secondary Pan

REALTIME MODULATION

In addition to keyboard and velocity modulation, Planet Phatt has multiple realtime modulation sources. Realtime modulation sources are parameters which can be continuously varied over time. The velocity and keyboard modulations, in comparison, are set at the key depression. The realtime modulation sources can control any of the destinations except sample start, Q, and tone, as indicated by the small arrows. Up to eight modulation routings can be programmed for each preset. The realtime modulation routings are completely flexible as shown in the example above.

MIDI REALTIME CONTROLS

The MIDI realtime controllers may seem confusing at first, but they are really very simple to understand. You probably already know that there are 16 MIDI channels that can be used. Each of the 16 MIDI channels uses basically 3 types of messages; *note on/off*, *program changes*, and *continuous controller* messages. Your MIDI keyboard, in addition to telling Planet Phatt which note was played, may also send *realtime control* information, which simply means occurring in real time or live. (You may be using a MIDI device other than a keyboard, but for simplicity's sake we'll presume that you're using a keyboard.) Realtime control sources include such things as pitch wheels or levers, modulation wheels or levers, control pedals, aftertouch, etc. and are used to add more expression or control. Your MIDI keyboard sends out realtime controller information on separate *continuous controllers*. There is a set of 32 continuous controllers for each of the 16 MIDI channels. Some of the controllers, such as pitch wheel, volume, and pan have been standardized. For example, volume is usually sent on continuous controller #7.

••• MIDI wind controllers may work better if you assign one of the MIDI A, B, C, D controllers to control volume. This will allow the MIDI volume to be **added** to the current volume.

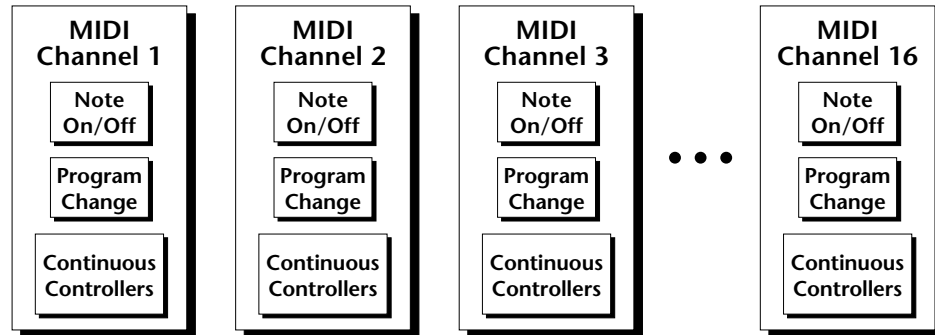

Common realtime controllers such as the modulation wheel (*or mod wheel*), volume, pan and pressure are pre-programmed to their proper destinations. Your keyboard may have other realtime controls such as a control pedal or data slider which can also be programmed to control most of the parameters on Planet Phatt.

Planet Phatt is equipped with a sophisticated *MidiPatch™ system*, which allows you to route any continuous controller to any realtime modulation destination. The *MidiPatch* system is also very easy to use. First, you must know which controller numbers your keyboard can transmit.

Let's say for example, that you are using a Yamaha DX7 as your master keyboard. The DX7 has pitch and mod wheels, a breath controller, a data slider and a foot pedal, all of which transmit their values over MIDI. The standard MIDI controller numbers for the controls are listed below (the pitch wheel has a dedicated controller, PWH). First, we would go to the Master menu, MIDI Controller Assign and define the 4 MIDI controllers that we wish to use. Assign each controller number to one of the letters A-B-C-D.

- 01 - Modulation Wheel A**
- 02 - Breath Controller B**
- 04 - Foot Pedal C**
- 06 - Data Entry D**

To complete the connections for a particular preset, go to the Edit menu, Realtime Control, and route the MIDI A, B, C, D to the desired destinations. These could be patched to any 4 destinations or even to the same destination. The MIDI Controller Amount menu, (in the Edit menu) allows you to scale the amounts of each of the controllers by a positive or negative value. The signal flow is shown in the diagram below.

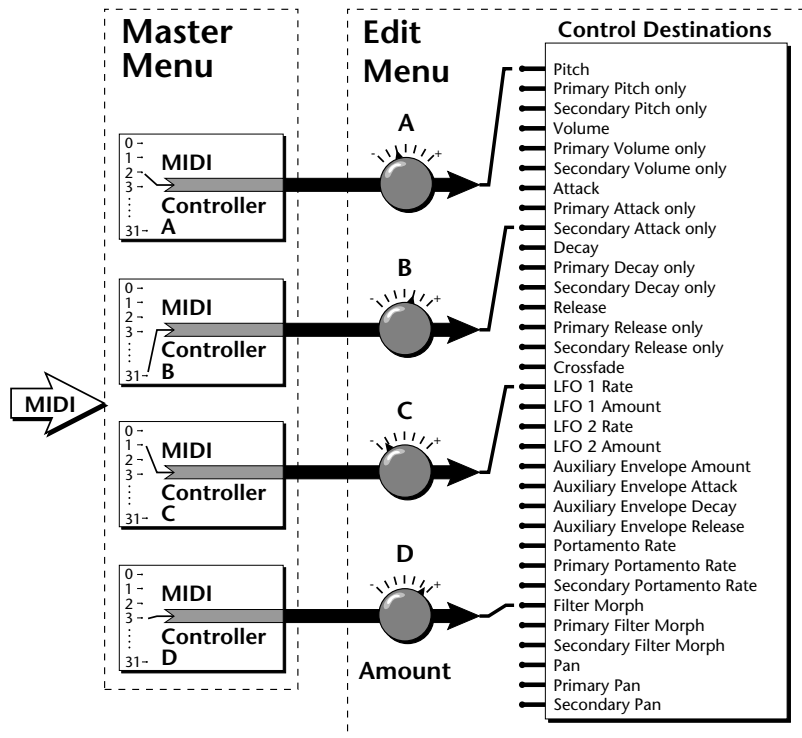

The MIDI controllers A-B-C-D must have both a source (0-31), and a destination assigned.

Standard MIDI Controller Numbers

- 1 Modulation Wheel
- 2 Breath Controller
- 3 Pressure Rev 1 DX7
- 4 Foot Pedal
- 5 Portamento Time
- 6 Data Entry
- 7 Volume
- 8 Balance
- 9 Undefined
- 10 Pan

STEREO MIX OUTPUTS

Planet Phatt has three sets of polyphonic stereo outputs (Main, Sub 1, Sub 2). The channels used by a particular preset may be directed to appear at any one of these three stereo outputs. This feature is useful for signal processing (EQ, reverb, etc.) of individual sounds prior to final mixdown. By panning a preset completely left or right, it can be routed to a single output jack.

Note: All presets will be automatically routed to the Main outputs unless plugs are inserted into the Sub 1 or Sub 2 outputs.

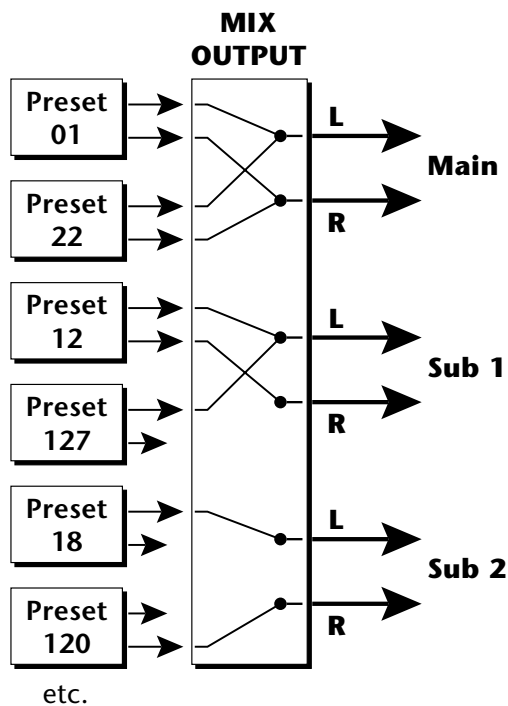

Each preset can be routed to one (and only one) set of stereo outputs.

PLAQUE
PHAT

EDIT MENU

The Edit menu contains functions that can be modified by the user and then saved as preset information in one of the user presets. For example, the LFO speed or other parameter can be edited, then the preset can be saved to a user location (Banks 0 & 1).

WARNING

Changes made in the Edit menu will be forever lost unless the preset is "saved" using the Save Preset function (page 79) before changing the preset.

To enable the Edit menu

Press the Edit key, lighting the LED. The current screen will be the one most recently selected since powering up the machine. The cursor will appear underneath the first character of the screen heading on line one.

To select a new screen

Press either cursor key repeatedly (or hold the right cursor key while turning the data entry control) until the cursor is underneath the parameter name. Rotate the data entry control to select the screen.

To modify a parameter

Press either cursor key repeatedly (or hold the right cursor key while turning the data entry control) until the cursor is underneath the parameter value. Rotate the data entry control to change the value.

To return to Preset Select mode

Press the Edit button, turning off the LED.

••• *While the Edit menu is activated, incoming MIDI preset changes are ignored. This is a quick and easy way to temporarily turn MIDI Preset Change OFF.*

EDIT MENU FUNCTIONS

- **Preset Name**

Preset Name allows you to name each of the user presets with a name of up to 12 characters. Position the cursor under the character location and use the data entry control to change the character. The keyboard can also be used to select characters. The charts below show the keyboard character assignment.

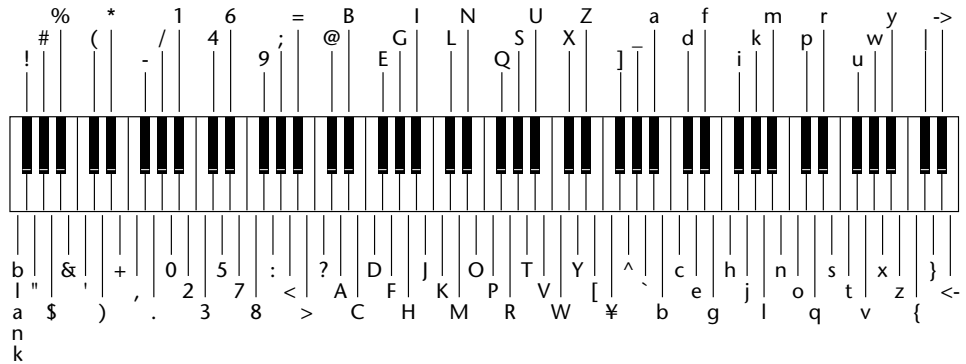
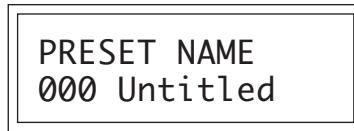

	C	C#	D	D#	E	F	F#	G	G#	A	A#	B	Pitch
-2						blank	!	"	#	\$	%	&	
-1	'	()	*	+	,	-	.	/	0	1	2	
0	3	4	5	6	7	8	9	:	;	<	=	>	
1	?	@	A	B	C	D	E	F	G	H	I	J	
2	K	L	M	N	O	P	Q	R	S	T	U	V	
3	W	X	Y	Z	[¥]	^	_	`	a	b	
4	c	d	e	f	g	h	i	j	k	l	m	n	
5	o	p	q	r	s	t	u	v	w	x	y	z	
6	{		}	→	←								

Octave No.

• **Primary Instrument**

This function allows you to select which of the available instrument sounds (or none) will be placed on the primary layer of the current user preset.



• **Secondary Instrument**

This function allows you to select which of the available instrument sounds (or none) will be placed on the secondary layer of the current user preset.



• **Key Range**

Key range sets the keyboard range of both primary and secondary instruments. This sets the keyboard range for the entire preset and will further limit the primary and secondary keyboard ranges. The key range can be set anywhere from C-2 to G8.

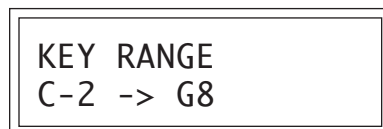

••• Simply changing the instrument creates a new sound while retaining all other parameters of the preset.

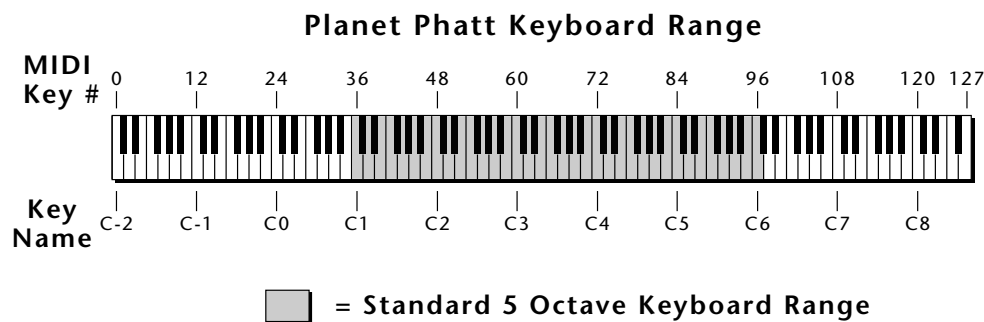

- **Primary Key Range**

Key range sets the keyboard range of the primary instrument. This is useful for creating positional crossfades and keyboard splits between the primary and secondary layers. The key range can be set anywhere from C-2 to G8.

```
KEY RANGE pri  
C-2 -> G4
```

- **Secondary Key Range**

Key range sets the keyboard range of the secondary instrument. The key range can be set anywhere from C-2 to G8.

```
KEY RANGE sec  
G#4 -> G8
```

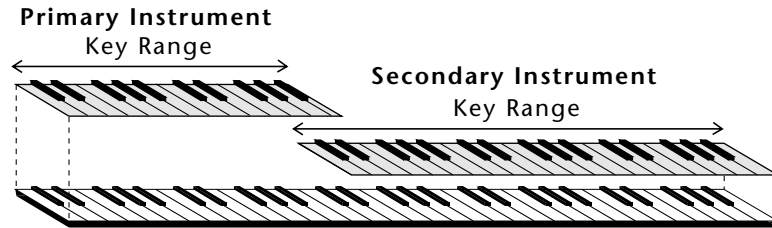

SPLIT KEYBOARD

This diagram shows how a "split" keyboard can be programmed using the primary and secondary instruments.

••• Entire presets can also be linked to form split or layered keyboards.

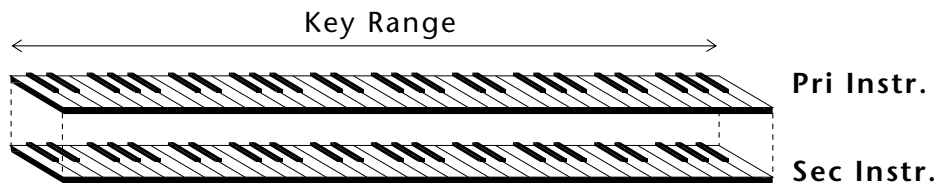

LAYERING TWO INSTRUMENTS

This diagram shows how instruments can be layered or "stacked" using the primary and secondary instruments.

- **Coarse Tuning**

This function allows you to change the tuning of the primary and secondary instruments in semitone intervals. The coarse tuning range is -36 to +36 semitones. A coarse tuning setting of "00" would indicate that the instrument is tuned to concert pitch (A=440 Hz).

```
TUNING coarse
pri:+00 sec:+00
```

- **Fine Tuning**

This function allows you to change the tuning of the primary and secondary instruments in 1/64 semitone intervals (approx. 1.56 cents). The fine tuning range is ± 1 semitone.

```
TUNING fine
pri:+00 sec:+00
```

- **Volume**

Volume sets the amplitude of the primary and secondary instruments. This function also allows you to compensate for the relative volume differences between instruments.

```
VOLUME
pri:127 sec:64
```

- **Pan**

Pan allows you to independently set the initial pan position of the primary and secondary instruments. A value of -7 pans the instrument hard left and a value of +7 pans the instrument hard right. This pan setting is only valid if "P", for preset pan, is selected in the main display.

```
PAN
pri:-7 sec:+7
```

• *Alternate Volume Envelope On/Off*

Each instrument has its own factory preset AHDSR volume envelope which is normally employed. If a programmable volume envelope is desired, the alternate envelope is used.

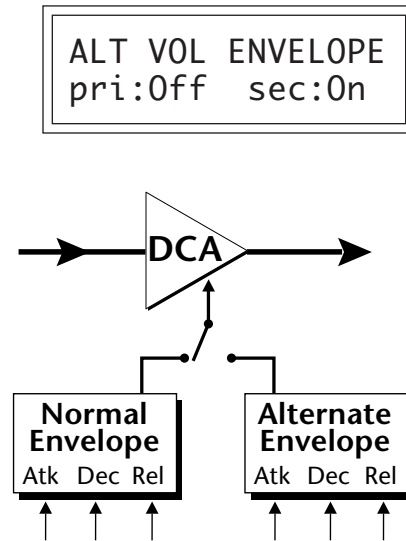

• *Primary Alternate Envelope Parameters*

This function allows you to adjust the alternate volume envelope parameters for the primary instrument. The parameters are Attack time, Hold time, Decay time, Sustain level, and Release time and are adjustable from 00 to 99.

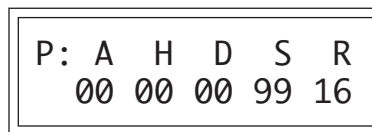

• *Secondary Alternate Envelope Parameters*

This function allows you to adjust the alternate volume envelope parameters for the secondary instrument. The parameters are Attack time, Hold time, Decay time, Sustain level, and Release time and are adjustable from 00 to 99.

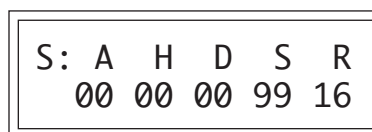

- **Delay**

Delay varies the time between when a MIDI Note On message is received and the onset of a note. The delay time is adjustable from 0 to 13 seconds (000-127).

```

DELAY
pri:000  sec:000

```

- **Sound Start**

This function allows you to set where a sample begins playing when you hit a key. A setting of 000 plays a sound from the beginning, higher values move the sample start point toward the end of the sound.

```

SOUND START
pri:000  sec:000

```

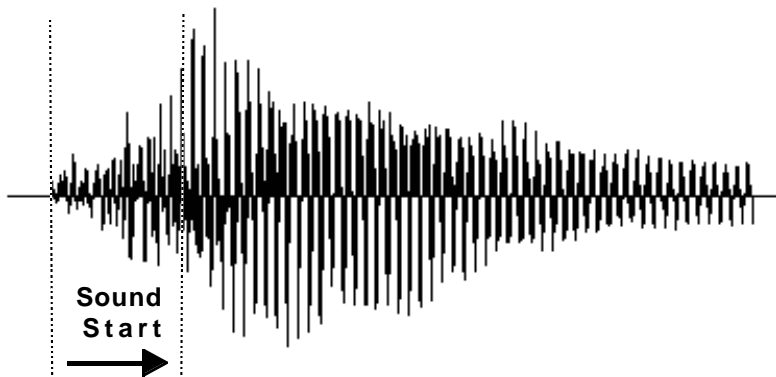

The Sound Start parameter allows you to cut off the beginning of the sound. Higher values move the start point toward the end of the sound.

- **Reverse Sound**

When reverse sound is turned On, the instrument will be played backwards. When an instrument is reversed, any loops in the sound will be ignored, which means that the sound will not sustain indefinitely.

```

REVERSE SOUND
pri:0ff  sec:0n

```

- **Solo Mode**

Solo mode provides the playing action of a monophonic instrument. This mode does not allow you to play a chord. Two types of solo mode are provided: wind controller mode and synth mode. Both modes have single triggering and last-note priority. In either solo mode, if a new note is played while another is being held, the envelope generators will not retrigger. This allows a legato playing technique to be used. Wind controller mode, as its name suggests, provides more realistic effects when working with wind controllers.

Wind mode

The envelope generator attack always begins at the start of the attack phase.

Synth mode

The envelope generator attack begins at whatever point the envelope is in when a new key is pressed.

```
SOLO MODE pri  
Off
```

- **Portamento Rate**

Portamento is a smooth gliding between notes instead of the normal instantaneous change in pitch when a new key is pressed. The portamento rate is the time it takes to glide to the new pitch. The larger the value, the slower the glide rate. The rate is adjustable from 1-127 or it can be turned Off. Portamento glides at a linear rate between notes and can be set separately for the primary and secondary layers. Portamento works both in and out of Solo Mode.

```
PORTAMENTO RATE  
pri:127  sec:Off
```

- **Chorus**

Chorus “thickens” the sound by doubling the sound and then detuning it. The chorus amount is variable over a range of 1 to 15. When Chorus is on, the number of channels used by an instrument will be doubled.

```
CHORUS  
pri:Off  sec:07
```

• **Crossfade Mode**

This function determines which of the following crossfade modes will be selected: Off, Crossfade, or Cross-Switch.

Off

When “Off” is selected, none of the crossfade parameters will have any effect.

Crossfade

When “Xfade” is selected, a control input is used to fade between the primary and secondary. Any modulation source may be used as an input (velocity, wheel, etc.).

Cross-switch

When “Xswitch” is selected, the switched layer is selected if the input crosses a certain threshold or if a footswitch controlling cross-switch is activated. The switch occurs only at the start of the note; no further switching takes place while the key is held down.

If key position or velocity is routed to cross-switch, the threshold is the *switch point*. Realtime controllers do not have any effect when routed to cross-switch. For more information, see Cross-Switch Point on page 67.

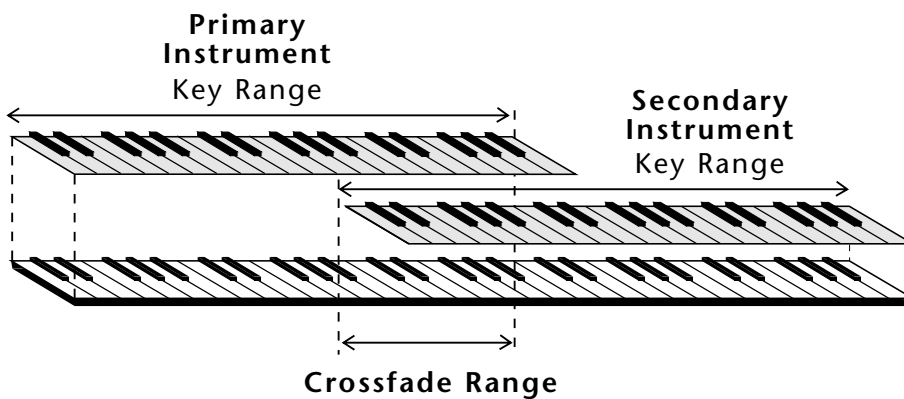
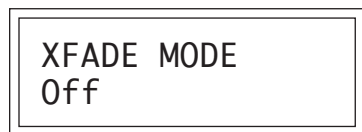

••• To use the keyboard for crossfade, set the Crossfade Balance to 64 and the Key Center to the split point.

By overlapping the primary and secondary instruments, you can crossfade or cross-switch between the layers.

• **Crossfade Direction**

This function determines the polarity of the crossfade or cross-switch. The direction is either primary → secondary, or secondary → primary.



• **Crossfade Balance**

The crossfade balance parameter determines the initial balance between the primary and secondary layers. Higher values shift the balance to the secondary instrument. When the Crossfade Direction is Pri->Sec, modulation subtracts from the primary volume and adds to the secondary volume. When crossfade modulation and balance equal 64, the two instruments are at equal volume.

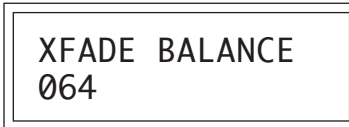

••• A Crossfade Balance setting of 000 would be appropriate with a source such as a modulation wheel or footpedal, either of which can only change the value in a positive direction.

▼ Crossfade must be assigned to a modulation source in the Realtime or Key/Velocity modulation screens.

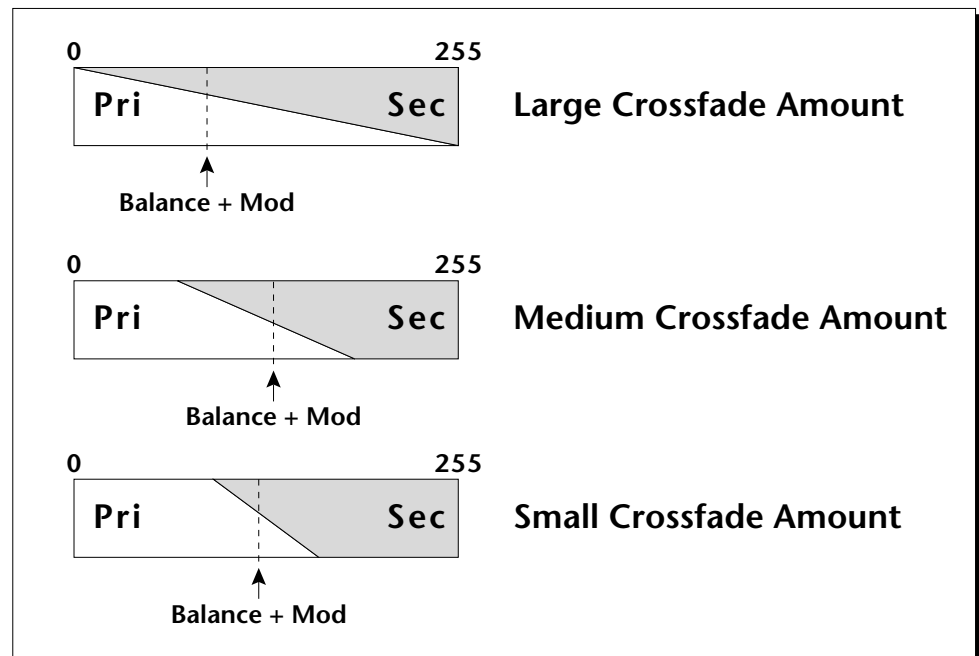

Modulation and Crossfade Balance are **added** together to determine the mixture of primary and secondary instruments. Higher values increase the secondary volume.

• **Crossfade Amount**

The crossfade amount parameter determines the range over which crossfading will occur. Crossfade amount is variable from 000 to 255. The larger the value, the more modulation will be required to effect a complete crossfade.

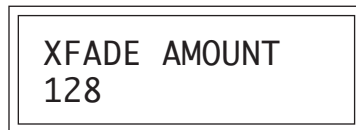

• **Cross-switch Point**

The cross-switch point determines the point at which cross-switching will occur when key position or velocity is controlling cross-switch.



• **Primary Filter Type**

This function selects the type of filter for the primary layer. 17 different filter types are provided. If no filtering is desired, you can bypass the filter by turning it Off.



FILTER TYPES

2-pole Lowpass

Lowpass filter with 12dB/octave rolloff and Q control.

4-pole Lowpass

Lowpass filter with 24dB/octave rolloff and Q control.

6-pole Lowpass

Lowpass filter with 36dB/octave rolloff and Q control.

2nd Order Highpass

Highpass filter with 12dB/octave rolloff and Q control.

4th Order Highpass

Highpass filter with 24dB/octave rolloff and Q control.

▼ To enable the cross-switch function, you must assign **Crossfade** to a modulation source in the Realtime or Key/Velocity Modulation screen.

2nd Order Bandpass

Bandpass filter with 6dB/octave rolloff on either side of the passband and Q control.

4th Order Bandpass

Bandpass filter with 12dB/octave rolloff on either side of the passband and Q control.

Swept EQ, 1-octave

Parametric filter with 24 dB of boost or cut and a one octave bandwidth. Fc controls center frequency and Q controls boost or cut.

Swept EQ, 2->1-octave

Parametric filter with 24 dB of boost or cut. The bandwidth of the filter is two octaves wide at the low end of the audio spectrum, gradually changing to one octave wide at the upper end of the spectrum. Fc controls center frequency and Q controls boost or cut.

Swept EQ, 3->1-octave

Parametric filter with 24 dB of boost or cut. The bandwidth of the filter is three octaves wide at the low end of the audio spectrum, gradually changing to one octave wide at the upper end of the spectrum. Fc controls center frequency and Q controls boost or cut.

Phaser 1

Creates a comb filter effect, typical of phase shifters. Filter Fc moves the position of the notches. Q varies the depth of the notches.

Phaser 2

Comb filter with slightly different notch spacing than Phaser 1. Filter Fc moves the position of the notches. Q varies the depth of the notches.

Bat-Phaser

Phase shifter with peaks as well as notches.

Flanger Lite

Contains three notches. Filter Fc moves frequency and spacing of the notches. Q increases flanging depth.

Vocal Ah-Ay-Ee

Vowel formant filter which sweeps from the "Ah" sound, through "Ay" sound to "Ee" sound at maximum Fc. Q varies the apparent size of the mouth cavity.

Vocal Oo-Ah

Vowel formant filter which sweeps from the “Oo” sound, through “Oh” sound to “Ah” sound at maximum Fc. Q varies the apparent size of the mouth cavity.

Bottom Feeder

This is a specialized distortion filter, useful for adding punch and drive to low frequency sounds such as bass and drums. Set the Fc low (less than 45) for best effect. Q has no effect on this filter.

• **Primary Filter Cutoff & Q**

This function allows you to set the cutoff frequency (the frequency at which filtering begins) and the Q or resonance for the lowpass and highpass filters. On a lowpass or highpass filter, turning up the Q causes the frequencies near the cutoff to be emphasized. On the other filter types, Fc and Q control various other parameters. See the filter descriptions of these functions.

FILTER	pri
Fc:255	Q:05

• **Secondary Filter Type**

Selects the filter type for the secondary instrument or the filter can be turned Off. See Primary Filter Type.

FILTER TYPE	sec
Vocal	Ah-Ay-Ee

• **Secondary Filter Cutoff & Q**

This is the same as the Primary Cutoff and Q for the secondary filter.

FILTER	sec
Fc:255	Q:05

• **Auxiliary Envelope**

This is a supplementary, utility envelope that can be routed to any realtime control destination including the filter. The auxiliary envelope parameters are: Envelope Amount, Delay, Attack Time, Hold Time, Decay Time, Sustain Level, and Release Time. The delay time is variable from 0 to 13 seconds (000-127). The envelope amount is variable from -128 to +127. Negative values will produce inverted envelopes.

```
AUX ENV AMT DLY
      +127 000
```

```
A: A H D S R
   00 00 00 99 20
```

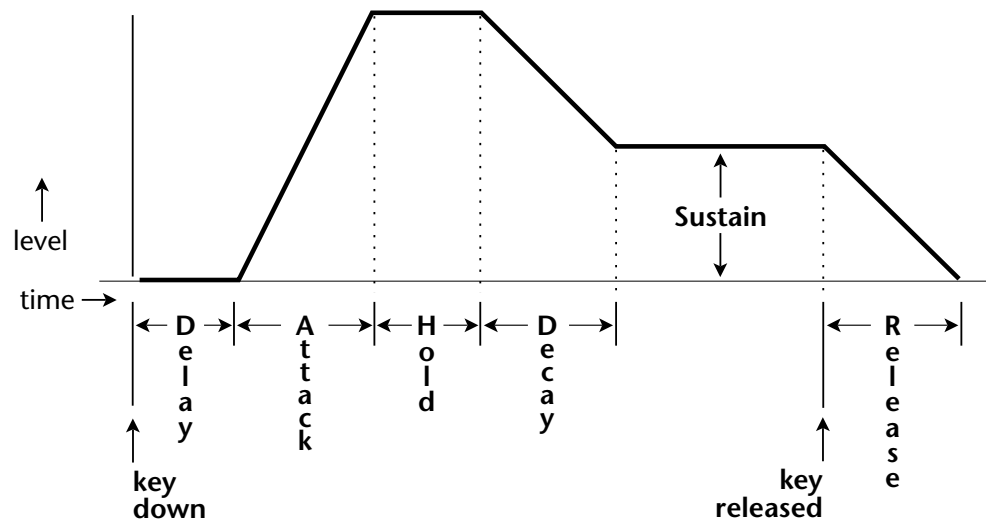

This diagram shows the six stages of the Auxiliary Envelope Generator.

• **LFO 1 - Shape & Amount**

This screen controls the waveshape and amount of Low Frequency Oscillator 1. The LFO can be used to produce vibrato (when routed to pitch), or tremolo (when routed to volume). The five LFO waveshapes are: Triangle, Sine, Square, Sawtooth, and Random. The amount can be varied from -128 to +127. Negative values will produce inverted waveshapes.

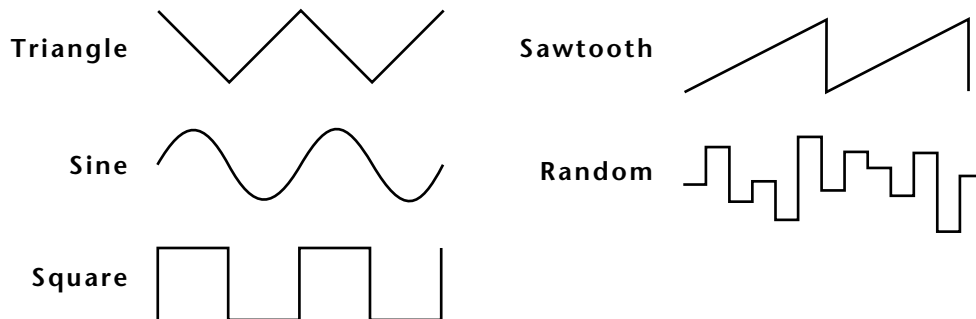
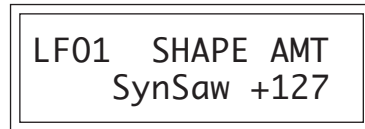

The Triangle, Sine, Sawtooth and Square LFO shapes can also be **Synced** to the Beats tempo or to external MIDI clock. The LFO waveforms preceded by “Syn” are synced LFO's. With the LFO synced to the beats tempo, the LFO rate will follow any changes in the beats tempo.

• **LFO 1 - Rate, Delay & Variation**

This screen controls the rate, delay and variation of LFO 1.

LFO Rate

Varies the LFO speed from 0.052 Hz to 25 Hz (000-127).

- Certain LFO rates are marked on Synced LFOs to show you that they correspond to various note values when synced to the Beats tempo.

LFO Delay

Sets the amount of time between hitting a key and the onset of modulation. This can be used to simulate an effect often used by acoustic instrument players, where the vibrato is brought in only after the initial note pitch has been established. The delay range is variable from 0 to 13 seconds (000-127).

••• **LFO Rates to Beats:**

- 004 Double Whole Note
- 006 Double Whole Triplet
- 013 Whole Note Triplet
- 017 Half Note
- 024 Half Note Triplet
- 030 Quarter Note
- 042 Quarter Note Triplet
- 051 Eighth Note
- 066 Eighth Note Triplet
- 077 16th Note
- 095 16th Note Triplet
- 109 32nd Note

LFO Variation

Sets the amount of random variation of an LFO each time a key is pressed. This function is useful for ensemble effects, where each note played has a slightly different modulation rate. The higher the number, the greater the note to note variation in LFO rate. LFO variation is variable from 000-127.

LFO1	RT	DLY	VAR
000	000	000	000

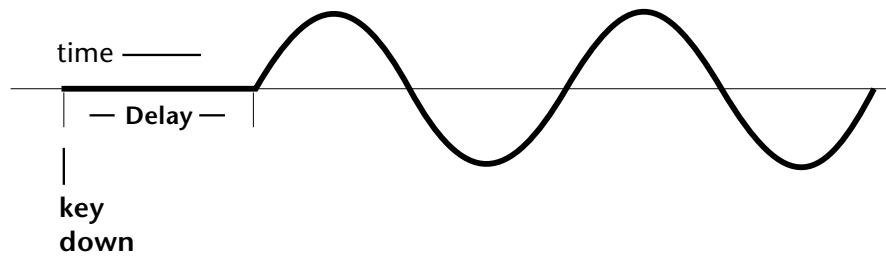

The LFO wave begins after the specified delay time has elapsed.

- **LFO 2 - Shape & Amount**

LFO 2 is functionally identical to LFO 1.

- **LFO 2 - Rate, Delay & Variation**

LFO 2 is functionally identical to LFO 1.

• **Keyboard & Velocity Modulation Control**

These functions allow you to route keyboard and velocity information to any of the modulation destinations. Up to 6 simultaneous paths or “patches” may be programmed. For each modulation patch, there is a source (keyboard or velocity), and a corresponding amount parameter which is variable from -128 to +127. **Place the cursor under the appropriate parameter and change the patch number, modulation source, modulation destination, or the amount using the data entry control.** If a parameter is not labeled either primary or secondary, it affects both.

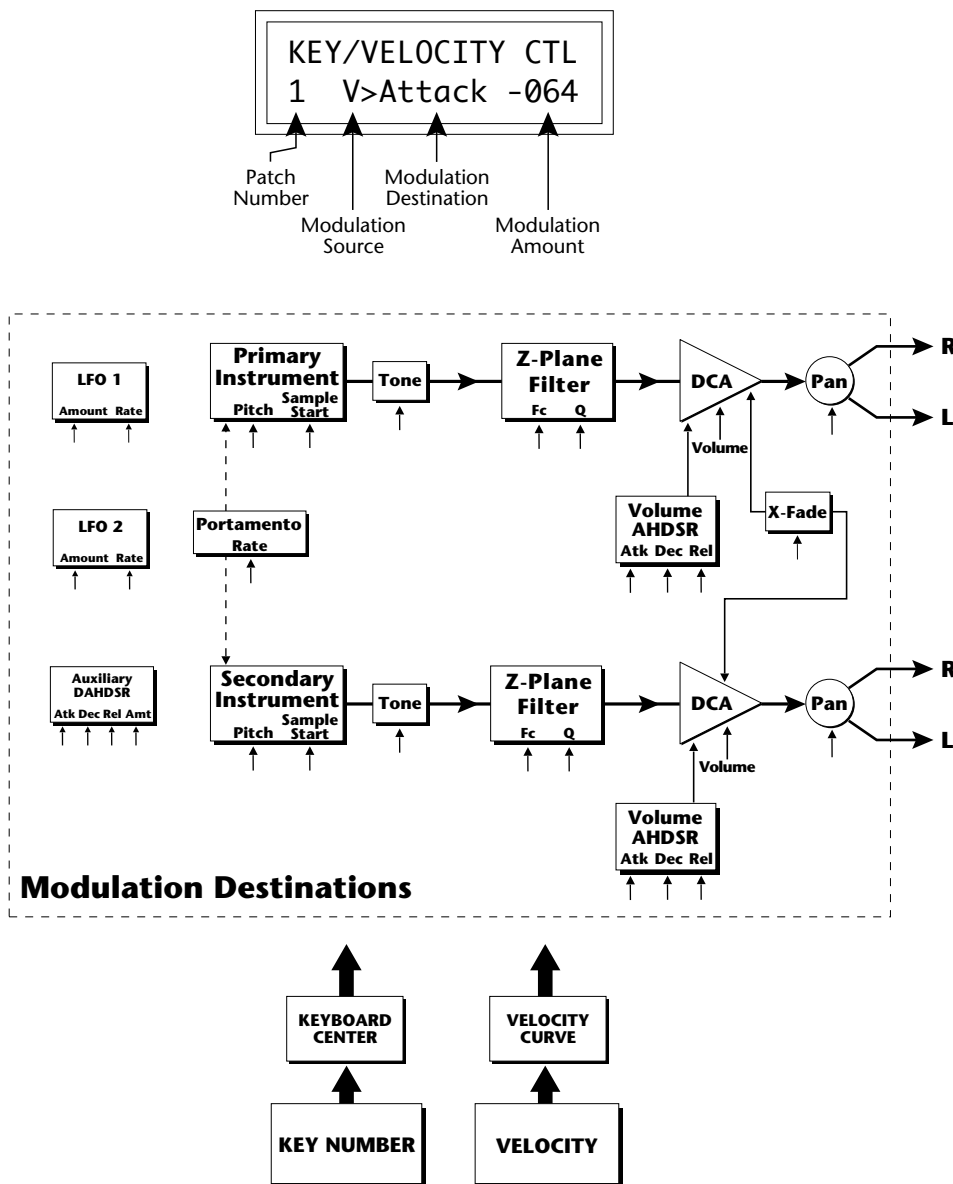

Keyboard and Velocity Modulation Sources

Keyboard

Modulation Sources
Key Number, Key Velocity

Destinations

Off,
Pitch, Primary Pitch,
Secondary Pitch,
Volume, Primary Volume,
Secondary Volume,
Attack, Primary Attack,
Secondary Attack,
Decay, Primary Decay,
Secondary Decay,
Release, Primary Release,
Secondary Release,
Crossfade,
LFO 1 Amount, LFO 1 Rate,
LFO 2 Amount, LFO 2 Rate,
Auxiliary Envelope Amount,
Auxiliary Envelope Attack,
Auxiliary Envelope Decay,
Auxiliary Envelope Release,
Portamento Rate,
Primary Portamento Rate,
Secondary Portamento Rate,
Filter Fc, Primary Filter Fc,
Secondary Filter Fc,
Filter Q, Primary Filter Q,
Secondary Filter Q,
Sample Start,
Primary Sample Start,
Secondary Sample Start,
Pan, Primary Pan,
Secondary Pan,
Tone, Primary Tone,
Secondary Tone

When Modulating Envelope Attack, Decay or Release Times:

Positive amounts of modulation **increase** the time.
Negative amounts of modulation **decrease** the time.

Realtime

Modulation Sources

Pitch Wheel,
MIDI Control A,
MIDI Control B,
MIDI Control C,
MIDI Control D,
Mono Pressure,
Polyphonic Pressure,
LFO 1, LFO 2,
Auxiliary Envelope

Destinations

Off,
Pitch, Primary Pitch,
Secondary Pitch,
Volume, Primary Volume,
Secondary Volume,
Attack, Primary Attack,
Secondary Attack,
Decay, Primary Decay,
Secondary Decay,
Release, Primary Release,
Secondary Release,
Crossfade,
LFO 1 Amount, LFO 1 Rate,
LFO 2 Amount, LFO 2 Rate,
Auxiliary Envelope Amount,
Auxiliary Envelope Attack,
Auxiliary Envelope Decay,
Auxiliary Envelope Release,
Portamento Rate,
Primary Portamento Rate,
Secondary Portamento Rate,
Filter Fc, Primary Filter Fc,
Secondary Filter Fc,
Pan, Primary Pan,
Secondary Pan

• Realtime Modulation Control

These functions allow you to route realtime controllers to any of the modulation destinations on except Tone, Sample Start, Q and Pan. Up to 8 simultaneous patches may be programmed. For each modulation patch, there is a source and a destination parameter. Place the cursor under the appropriate parameter and change the patch number, modulation source or modulation destination using the data entry control. If a parameter is not labeled either primary or secondary, it affects both.

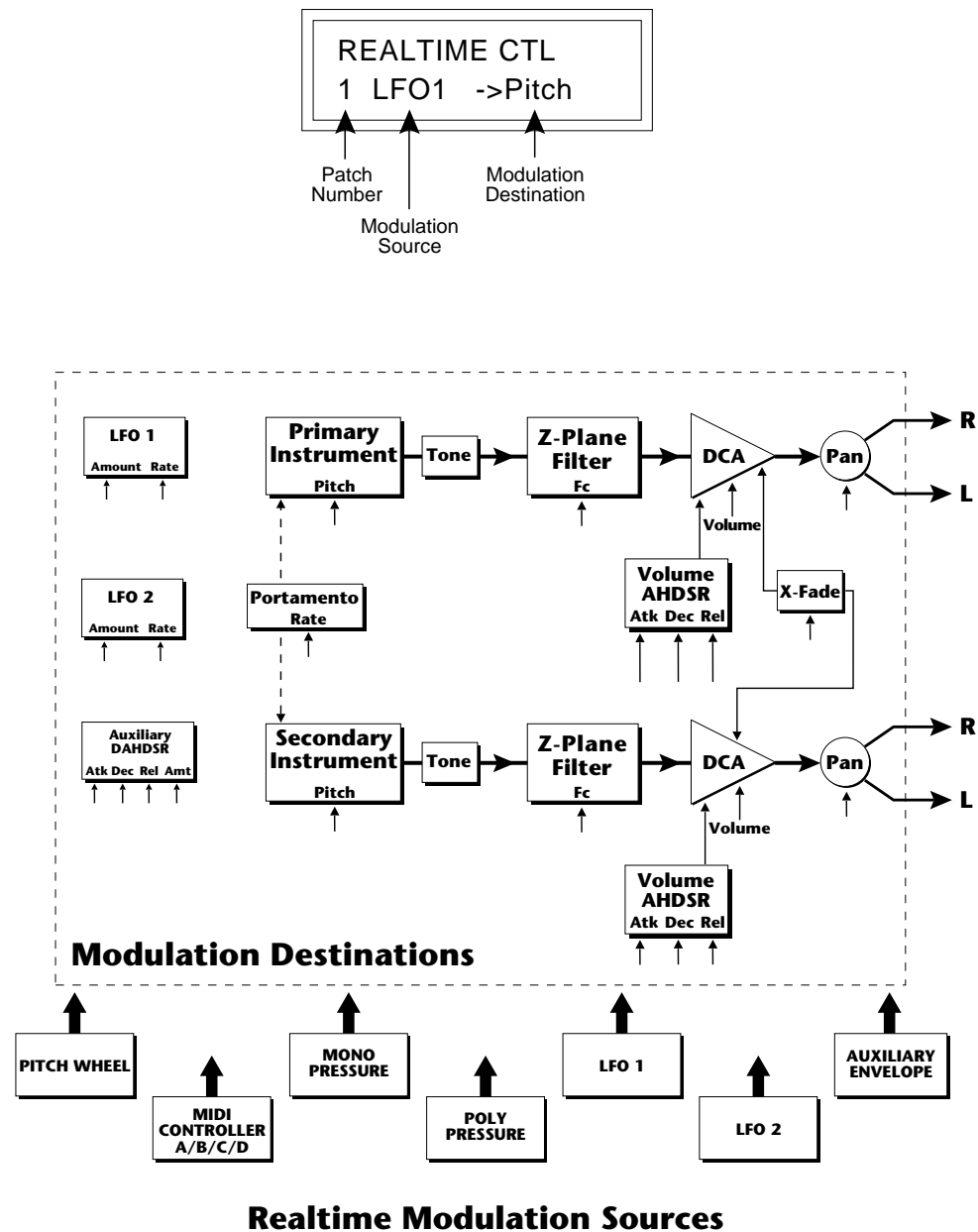

- **Footswitch Control**

This function allows you route the 3 footswitch controllers (1, 2 or 3) to any of the footswitch destinations. The footswitches can be routed to switch: Sustain (pri/sec/both), alternate volume envelope (pri/sec/both), alternate volume release (pri/sec/both), or cross-switch between the primary and secondary instruments.

```
FOOTSWITCH CTL
1 -> Sustain
```

- **Pitch Bend Range**

This function allows you to specify the pitch wheel range for the current preset or it can be set to be controlled globally (set in the Master menu). Pitch bend range is only applied when the pitch wheel is used to control pitch.

```
PITCH BEND RANGE
+/- 12 semitones
```

- **Pressure Amount**

This function allows you to specify an amount parameter for mono or poly keyboard pressure data. The pressure amount is variable from -128 to +127.

```
PRESSURE AMOUNT
+127
```

- **MIDI Controller Amount**

This function allows you to specify an amount parameter (variable from -128 to +127) for each of the MIDI controllers.

```
CONTROLLER AMT
A:+127  B:-090
```

```
CONTROLLER AMT
C:+030  D:+060
```

• **Velocity Curve**

Incoming velocity data can be modified by a velocity curve in order to provide different types of dynamics in response to your playing or better adapt to the MIDI controller. This function allows you to select one of the four velocity curves or leave the velocity data unaltered (Off). In addition, the velocity curve can be set to “Global”, which means that the global velocity curve (programmed in the Master menu) is used.

VELOCITY CURVE
Global

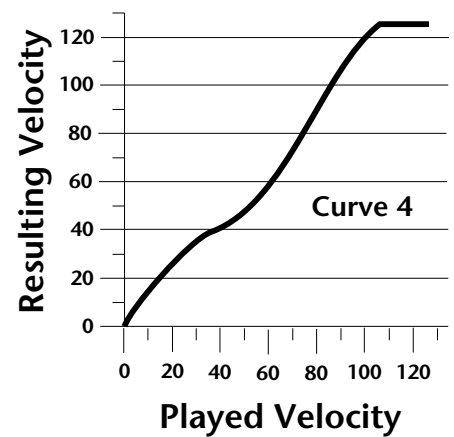
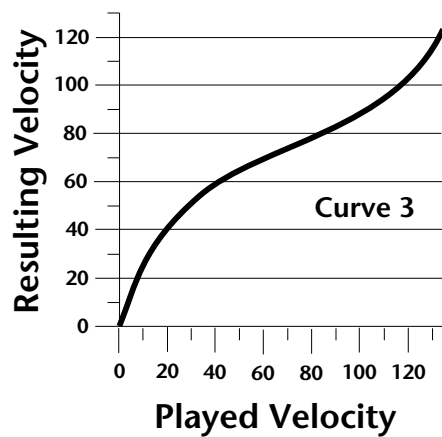
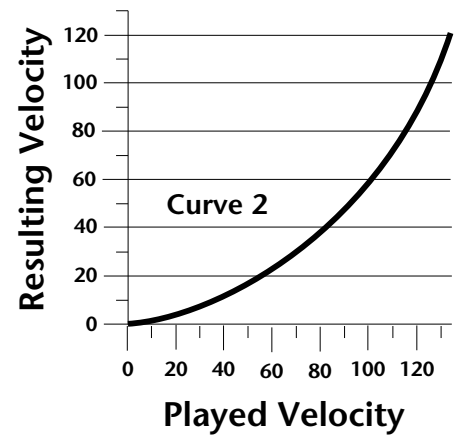
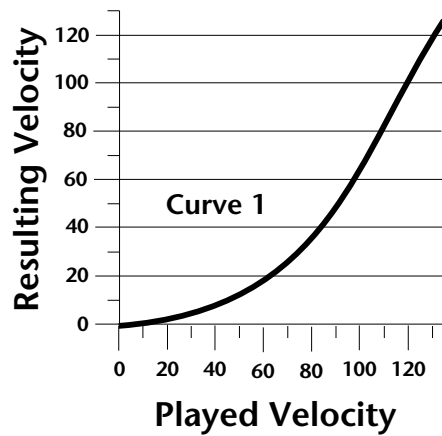

• **Keyboard Center**

The Keyboard Center parameter establishes a reference point for keyboard modulation. Keys above this point will have a positive value and keys below it will be negative. The keyboard center can be set to any key within the range C-2 to G8.

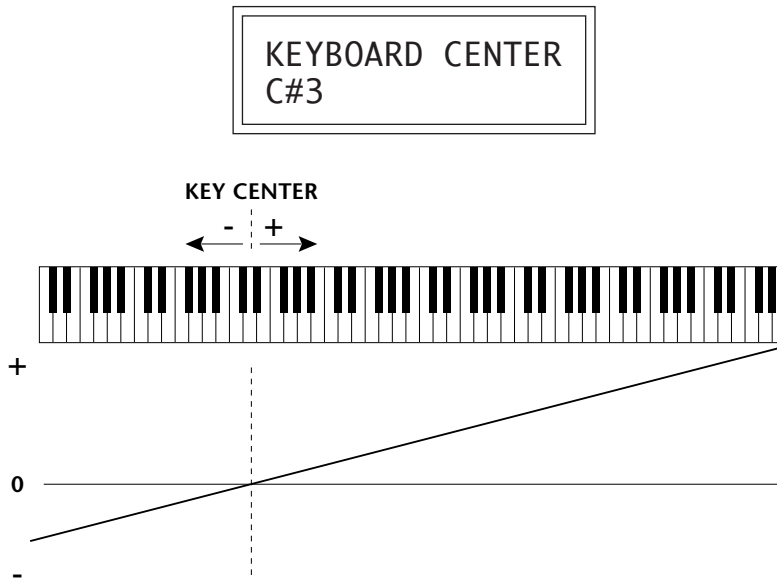

• **Keyboard Tuning**

In addition to the standard equally divided octave tuning, Planet Phatt contains three other types of scale tuning and one user-definable tuning. This function selects which tuning will be used in the current preset. The choices of keyboard tunings are:

Equal tuning (12 tone equal temperament)

Standard Western tuning.

Just C tuning (just intonation)

Based on small interval ratios. Sweet and pure, non-beating intervals.

Vallotti tuning (Vallotti & Young non-equal temperament)

Similar to 12 tone equal temperament. For a given scale, each key has a different character

19 Tone tuning (19 tone equal temperament)

19 notes per octave. Difficult to play, but works well with a sequencer.

Gamelan (Javanese) tuning (5 tone Slendro and 7 tone Pelog)

Pelog-white keys, Slendro-black keys. Exotic tunings of Gamelan flavor.

User Tuning

Defined in the Master menu.

••• Presets assigned to the Sub 1 or Sub 2 outputs will appear at the Main outputs if plugs are not inserted into the Sub 1 or Sub 2 jacks.

• Mix Output

This function allows you to direct the channels used by a particular preset to appear at one of these three stereo outputs (Main, Sub 1, Sub 2).

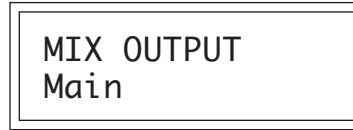

• Preset Links

Presets may be linked to other presets in order to create layering or keyboard splits. The current preset can be linked with up to three other presets. Each linked preset can be assigned to a specific range in order to easily create keyboard splits. The modulation parameters and Mix Output assignments specified in each preset remain in effect for each preset in the link.

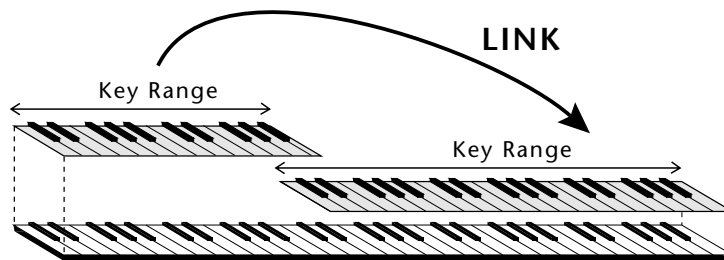
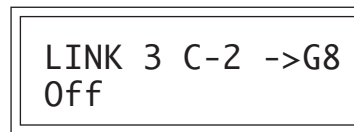

CREATING A SPLIT KEYBOARD

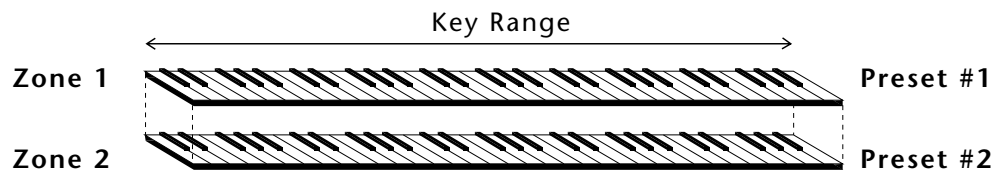

LAYERING TWO PRESETS

- **Save Preset**

Changes made to a preset in the Edit menu are not made permanent until the preset is *Saved*. To save a preset, move the cursor to the bottom line and select the location for the new preset with the data entry control. The Enter LED will be flashing. Pressing the Enter switch will confirm the operation. Any user preset (Banks 0 & 1) may be selected using the data entry control. Writing to a user preset erases the existing preset in that location. Make sure that the destination preset does not contain information that you want to keep.

SAVE PRESET to
064⁰ Preset Name

To Save a Preset

1. Select the new location.
2. Press Enter.

PLAQUEET
PHATET
STEP-BY-STEP

This section contains step-by-step instructions on how to get started in programming your own custom sounds. It is recommended that you actually try each example on Planet Phatt unit, rather than just reading through. The best way to learn something is by actually doing it.

LINKING PRESETS

Linking presets is a quick and easy way to create new sounds by “layering” presets and also to “split” a keyboard into sections containing different sounds.

• *Layering Two Presets*

- 1) Select the first preset you wish to layer.
- 2) Press the Edit button.
- 3) Use the data entry control to move through the screens until you find one of the “LINK” screens.
- 4) Move the cursor to the second line of the display, then select the preset that you want to be linked with this preset. You may want to play the keyboard as you scroll through the various presets in order to hear the results.
- 5) If you want the link to be a permanent part of the preset, be sure to “SAVE PRESET”. Otherwise, simply change the preset to erase your work.

• *Create a Split Keyboard Using Links*

- 1) Follow steps 1 through 4 above.
- 2) Now set the range of the linked preset while still in the LINK menu.
- 3) Save the preset.
- 4) Now go back to the first preset, press the Edit button and use the data entry control to move through the screens to KEY RANGE.
- 5) Set the range of this preset so that it fills the remaining range of your keyboard.
- 6) Save the preset.

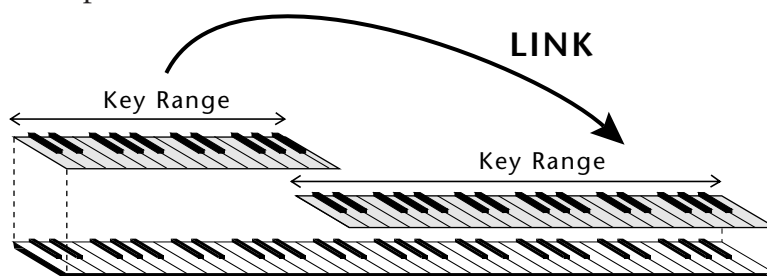

CREATING A SPLIT KEYBOARD

••• *To get the most out of this section, please read Chapter 4, Programming Basics first.*

EDITING PRESETS

The easiest way to make a new preset is to edit an existing preset. This is also an excellent way of becoming familiar with Planet Phatt. If you don't like what you hear, simply change the preset and Planet Phatt reverts back to the original sound. Changes are not made permanent until you **Save** them using the "SAVE PRESET" function, which is the last screen in the Edit menu. Let's experiment and modify a few parameters of an existing preset. We'll start with functions that have an obvious effect on the sound: Instrument Select, Coarse Tuning, Chorus and Reverse Sound. First, choose any cool preset and press the Edit button.

- **Changing the Instrument**

This is probably the easiest and most dramatic way to modify an existing preset. Scroll through the Edit menu functions until you come to:

```
INSTRUMENT pri  
IXXX Instr Name
```

Move the cursor down to the bottom line (using the cursor button) and change the primary instrument with the data entry control. Play the keyboard as you scroll through the various instruments. When you find an interesting instrument, move the cursor back up to the first line and select:

```
INSTRUMENT sec  
IXXX Instr Name
```

Repeat the process for the secondary instrument. Find an instrument that sounds good when combined with the first one you selected. You can probably see that with all these great instruments to work with, you really can't go wrong. Now let's play with the tuning.

CHANGING THE TUNING OF AN INSTRUMENT

Scroll through the Edit menu functions until you come to:

```
TUNING coarse  
pri:+00 sec:+00
```

If the numbers are “00” as in the previous screen, it means that the instruments are tuned to concert pitch (A=440 Hz). Each whole number in coarse tuning represents a semitone interval. To tune one or both of the instruments up an octave, move the cursor to the number (using the cursor button) and set the number to +12 using the data entry control. Try tuning one of the instruments to a perfect fifth above the other. Simply set the coarse tuning to +7.

Tuning an instrument far out of its normal range will completely change the character of the sound. For example, if you tune a bass guitar up 2 octaves, it's going to sound rather petite. On the other hand, if you tune it down 2 octaves, you can probably rattle plaster off the walls! Experiment with radical pitch shifting. You'll be surprised at the results.

CHORUS

This is an easy one. With the cursor on the top line of the display, turn the data control until you find CHORUS. Various amounts of chorusing can be selected for each of the primary and secondary instruments. Chorus works by doubling the instruments, detuning and panning them slightly. The larger the number, the more detuning will occur. *Warning: Since it works by doubling the instruments, chorus halves the number of notes you can play on Planet Phatt.* Chorus is useful when you want to “fatten up” a part quickly and easily. Just turn chorus on!

```
CHORUS
pri:07  sec:0ff
```

REVERSING THE INSTRUMENT

A simple concept. The instrument sounds can be played in reverse. This will normally make an instrument sound quite a bit different. It also virtually doubles the number of raw instruments you have to work with, and it's fun.

```
REVERSE SOUND
pri:0ff  sec:0ff
```

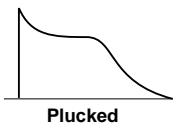
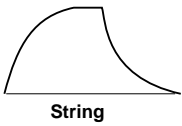
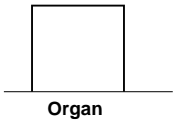
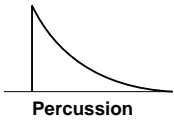

••• The generalized volume envelope shapes of a few types of sounds are shown above.

ALTERNATE VOLUME ENVELOPE

Every sound you hear, be it a piano note, a drum, a bell or whatever, has a characteristic volume curve or envelope, which grows louder or softer in various ways during the course of the sound. The volume envelope of a sound is one of the clues that our brain uses to determine what type of sound is being produced.

Each instrument has its own volume envelope which is used when the Alternate Envelope parameter is turned Off. By turning the Alternate Envelope On, we can re-shape the instrument's natural volume envelope any way we want. By reshaping the volume envelope of an instrument, you can dramatically change the way the sound is perceived. For example, by adjusting the envelope parameters, you can make "bowed" pianos or backwards gongs. The diagrams at the left show the volume envelopes of a few common sounds.

In preparation for this experiment choose a fairly "normal" preset (like an organ or synth) which continues to sustain when the key is held down. Go to the Secondary Instrument screen and set it to "None".

Next go to the Alt. Volume Envelope screen and turn the Primary Volume Envelope On.



Now move on to the next screen:

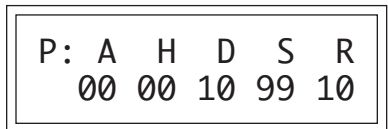

Increase the Attack time and play a note. The attack controls the time it takes for the sound to reach full volume when a key is pressed and held.

Now increase the Release time and note the effect as you release the note. The Release time controls the time it takes for the sound to die away when a note is released.

• Anatomy of an Envelope

When a key is pressed, the envelope generator starts increasing at the **Attack** rate. When it reaches full level, it **Holds** at that level for the **Hold** time. After the Hold time has elapsed, the envelope begins to **Decay** back down at the specified Decay rate until it reaches the **Sustain** Level. Note that all the other parameters are *Times*, but the Sustain is a *Level*.

The envelope will stay at the Sustain level for as long as the key is held. When the key is released, the envelope falls back down to zero at the Release rate.

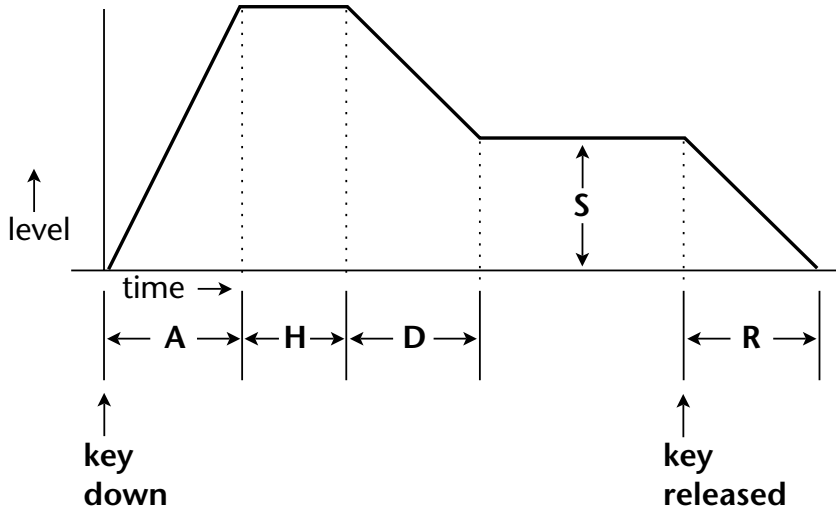

WORKING WITH THE FILTER

The low pass filter makes it possible to remove certain components of the sound. A low pass filter removes the high frequency components or put another way, it “lets the lows pass”. In preparation for this experiment choose a fairly “normal” preset (like an organ or synth). Go to the Secondary Instrument screen and set it to “None”, then set the Primary Instrument to one which is rich in harmonics, such as Instrument I074 Clavinet. (Since filters work by removing or accentuating certain frequencies, we want to make sure that we have a lot of frequencies to start with.) Set the parameters as listed in the chart below in order to “clean the slate” for your filter investigation.

Go to the primary filter cutoff and Q screen shown on the following page and position the cursor below the Fc value.



Primary	
Instrument:	074 Clavinet
Tuning course:	+00
Volume:	+127
Alt. Vol. Envelope:	Off
Realtime CTL:	1-8 -> All Off
Filter Type Pri:	4 Pole Lowpass
Filter Fc:	255
Filter Q:	00
Aux Envelope Amt:	+100
Aux Env:	A H D S R 28 00 33 00 16

Playing the keyboard now, you should hear the raw Clavinet sound. Slowly decrease the filter Fc as you play the keyboard. The sound will get duller and duller as more and more high frequencies are filtered out until at some point the sound will completely disappear. (You have filtered out everything.) The chart below illustrates what you just did. You moved the cutoff frequency down.

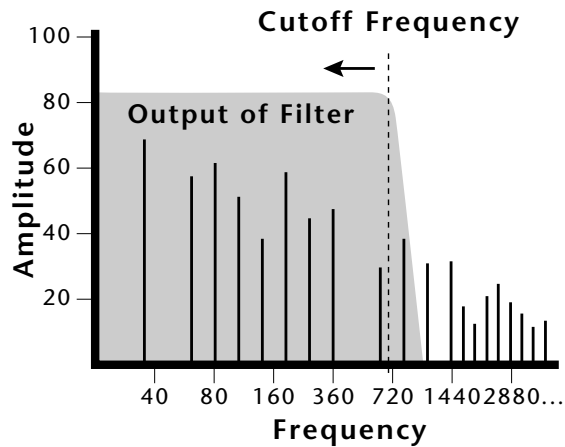

Open the filter back up to 255, then move the cursor underneath the Q. Set the Q to 10, then move the cursor back under the Fc. As you change the Fc, notice that the sound now has a sharp, nasal quality. With a high Q, frequencies at the cutoff frequency (Fc) are being boosted or amplified.

Now let's modulate the filter Fc with the Auxiliary envelope generator. The envelope generator is a device that can automatically change the filter Fc during the course of the note. Set the Fc way down until you can just hear the sound (about 60), then press Enter and go to the REALTIME CTL screen.

```
REALTIME CTL
1 PWhl -> Off
```

Move the cursor down underneath the source and set it to Aux (for Auxiliary Envelope). Next move the cursor underneath the destination and set it to Filter Fc. The screen should look like this:

```
REALTIME CTL
1 Aux -> FiltFc
```

You have just connected the Auxiliary Envelope Generator to the Filter Cutoff as shown in the diagram below.

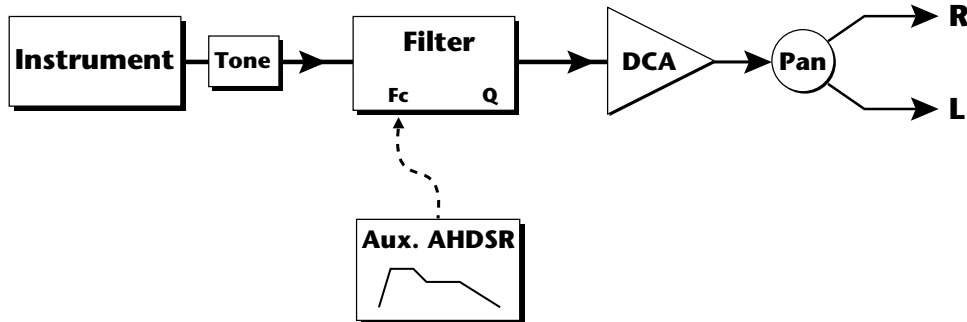

Now go back to the Aux Envelope screen.

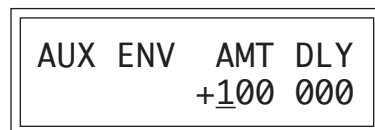

Move the cursor underneath the envelope amount and change the value to about +100. Now when you press a key the filter will slowly sweep up. Because the filter Q is set high, you can hear the different harmonics of the sound being accentuated as the filter cutoff sweeps past.

Now, scroll back to the Auxiliary Envelope parameter screen.

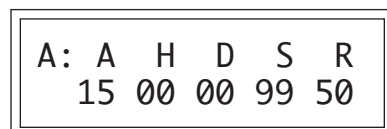

Change the attack rate and note the change in the sound. The diagram below shows approximately how the envelope looks when the parameters are set as shown above.

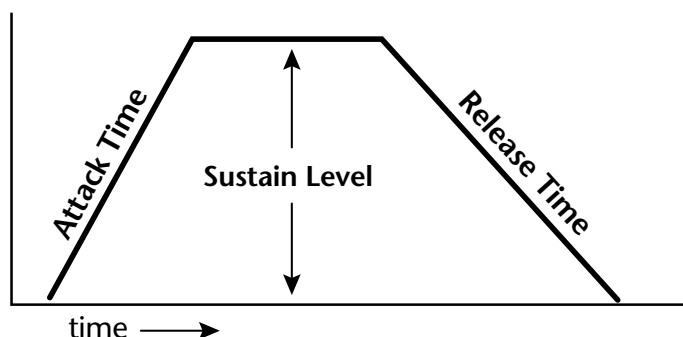

••• Note that all the envelope parameters are **Rates** except for **Sustain**, which is a **Level**.

STEP-BY-STEP

Because the Sustain level is set to maximum, the decay parameter has no effect. Set the parameters as shown below.

```
A: A H D S R
   03 06 24 36 12
```

Now the filter sweeps up, **Holds** there for a bit, then **Decays** back down to the **Sustain** Level until you release the key. Then it sweeps down at the **Release** rate. Play with the envelope parameters for awhile to get a feel for their function. (If you're having trouble understanding the Envelope Generators, please refer to the Programming Basics section in this manual.)

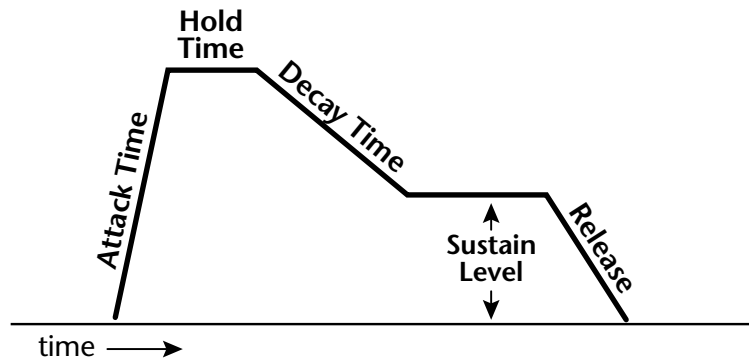

Go back to the Primary Filter Type screen shown below and move the cursor down the lower line of the display. Change the filter type while playing the keyboard.

```
FILTER TYPE pri
2nd Ord Hipass
```

These filters are extremely powerful and have been carefully crafted to offer maximum flexibility and musical control. You may want to change the **Envelope Amount**, **Q** and/or the **Filter Cutoff** to get the right sound for each filter and instrument. These three controls, coupled with the Aux. Envelope, are perhaps the most important controls on Planet Phatt. Take the time to learn how they interact with each other and you will be able to create just about any type of sound you want.

• **Troubleshooting**

A common source of confusion when working with the filter envelope is that the Attack or Release parameter might not seem to be working correctly. Referring to the diagram below which shows the Planet Phatt signal flow, you will notice that the DCA comes **after** the Filter. The DCA controls the final volume of the sound, so if the filter's release is longer than the release for the DCA, you won't hear it, because the DCA has already shut off the sound.

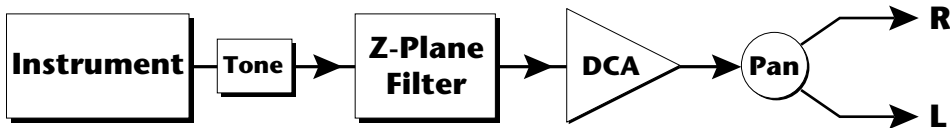

This is just an example of why troubleshooting is important. If you are not getting the expected result, try to analyze the situation. There will be many times when you will have to stop for a minute and think, “What am I trying to do and why isn't it working?” When this happens (*and it will*), don't panic. Troubleshooting is a normal part of the synthesis process. Simply examine the various parameters and try to be as analytical as possible as you solve the problem. Usually the solution will be simple. (The filter is already wide open and can't open any more.) Learning to play an instrument takes... Practice.

You're probably getting the general idea by now. Remember not to change presets or the preset will return to normal. If you want to save your creation, select the last screen in the Edit menu and select a destination preset location for your masterpiece, then press Enter.

Practice Modulating

- Try modulating the pitch with the Aux. Envelope generator
- Use velocity to modulate the Aux Envelope Amount or the filter Fc. (Key/Vel. screen). This will brighten the sound as you play harder.
- Program the LFO to modulate filter Fc and volume (Realtime modulation screen).
- Modulate the LFO with the other LFO, with velocity, and with the modulation wheel.
- Think of ten different modulation routings, then try them out. The key to learning about Planet Phatt is to experiment.

••• Presets can be stored in any of the non-volatile RAM locations (Banks 0 & 1).

USING PLANET PHATT WITH A SEQUENCER

We thought you'd never ask. Planet Phatt was designed from its conception with multi-timbral sequencing in mind. Just take a look at the main screen.

```
C01 Vol127 Pan=P
000 Preset Name
```

The preset for each MIDI channel is selected from the main screen. Press the cursor button to move the cursor up so that it is underneath the channel number.

```
C01 Vol127 Pan=P
000 Preset Name
```

Turn the data entry control and you will see that every MIDI channel has a preset assigned to it. Just select a preset for each of the MIDI channels. It's simple! In order to respond to multiple MIDI channels, Planet Phatt must be in Multi-Mode. Multi-Mode is selected in the Master menu. Press the Master menu button and use the data entry control to scroll through the screens until you find MIDI MODE.

```
MIDI MODE    ID
Multi       00
```

Move the cursor down to the second line and change the mode to **Multi** as shown. Planet Phatt will now respond to multiple MIDI channels.

MORE ADVANCED SEQUENCING

• *Pre-Sequence Setup*

Suppose that you want to have your sequencer set up everything for you before the start of the song. Good idea. This will make the setup procedure automatic and prevent the wrong presets from playing.

The basic idea of a pre-sequence setup is to send out MIDI information just before the start of the song. This MIDI information will select all the proper presets, adjust the mix, and pan positions of each preset.

Note: Planet Phatt setup information should be transmitted from the sequencer *before* the song actually starts, perhaps during a lead-in measure or countdown. DO NOT send setup information just before the first beat of the song or MIDI timing errors could result.

• *Initial Setup*

In the Master menu:

- 1) Turn ON Multi-Mode
- 2) Turn ON Preset Change enable for each channel.
- 3) Turn OFF MIDI Enable on MIDI channels that are to be used for other synthesizers.

• *Preset, Volume & Pan Setup*

Program your MIDI sequencer to transmit the following information before the song starts.

- 1) Select the proper presets for each MIDI channel used on Planet Phatt.
- 2) Send MIDI volume information (controller #7) for each MIDI channel used on Planet Phatt.
- 3) Send MIDI pan information (controller #10) for each MIDI channel used on Planet Phatt.

Now your song will play perfectly every time using the proper presets, volumes and pan positions. In addition, presets, volumes and pan positions (or anything else for that matter) can be adjusted in realtime during the song. Note: If the wrong presets are being selected, check the MIDI Program -> Preset map.

To carry the pre-sequence setup even further, you can even include preset data for each preset used in the sequence. See page 30 for details.

• *Using the 32 Channels*

As stated earlier, Planet Phatt has 32 independent audio channels which are utilized dynamically. With 32 channels and 640 presets, you have a universe of sonic textures at your disposal. You may have noticed that some of the very big sounding presets in Planet Phatt are *linked* with other presets or they have *chorus* applied to them. While this is fine when the preset is played solo, you may begin to run out of channels when Planet Phatt is played multi-timbrally. Linking and chorusing cause twice as many channels to be used by the preset. Learn to “budget” your output channels for maximum efficiency.

••• *The Preset, Volume and Pan information for all 16 channels is included when the Master Settings are transmitted or received over MIDI.*

• **Channel Ripoff**

When Planet Phatt uses up all its 32 channels and needs more, it steals a channel from the key that has been in the release phase longest. This is commonly known as “channel rip-off”. You will most commonly encounter this “rip-off” when using Planet Phatt in multi-timbral mode or when using massive preset links. Since Planet Phatt dynamically allocates channels as needed, to eliminate rip-off you must either, play fewer notes, use simpler sounds, turn off doubling (pri/sec, chorus, or linked presets), or use MIDI overflow to another Planet Phatt unit.

• **Using External Processing**

Don't be afraid to use external processing on specific sounds if you feel the urge. The submix sends and returns on Planet Phatt are there for a reason. In many instances a bit of reverb or EQ will be just the thing an instrument needs to give it a distinct identity. Incidentally, an external fuzz box can work wonders on otherwise harmless sounds. By dedicating one of your old fuzz boxes to a submix out/in, you can have programmable distortion for use on basses, organs or whatever.

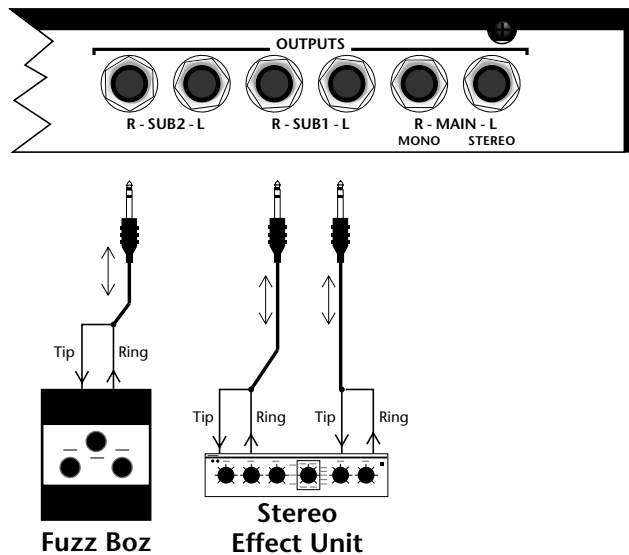

Using the programmable outputs and returns, specific presets can be routed through your favorite effects without using up precious mixer channels.



REFERENCE SECTION

FACTORY RAM PRESETS - BANK 0

Bank	Contents
0	— 128 RAM Presets
1	— 128 RAM Presets
2	— 128 ROM Presets
3	— 128 ROM Presets
4	— 128 ROM Presets

••• Preset Categories:

bas: .. Bass
bts: .. Used in beats preset
cmp: Comp
epo: . Electric piano
led: .. Lead instrument
gtr: .. Guitar
hit: ... Orchestra hit
org: .. Organ
pad: . Thick sustained sound
prc: .. Percussion
rif: Short musical line
sbs: .. Sub bass
scr: ... Record scratch
sfx: ... Sound effect
syn: .. Synthesizer
vox: .. Human voice

0.	sbs:1st Bass	43.	org:Thunder	86.	pad:Lokke
1.	sbs:Glibby	44.	org:Cheezey1	87.	vox:Cumming
2.	led:Romance	45.	org:Hitted	88.	vox:Funee
3.	gtr:Guit Hit	46.	org:Low Harm	89.	vox:SoulWhl
4.	brs:Brassy	47.	org:KorusBoy	90.	vox:ModTalkr
5.	epo:Wrodes	48.	org:EnsOrgn	91.	vox:Voxxin
6.	cmp:DirtRoll	49.	org:DanceOrg	92.	sfx:Uluoo
7.	hit:DanceBak	50.	org:Dissinit	93.	sfx:Phad
8.	scr:Skratch	51.	org:OldTimes	94.	sfx:Rekerdz
9.	prc:RuffDrum	52.	org:Swirl	95.	sfx:Assidik
10.	sbs:Wetnick	53.	org:EnsOrgn	96.	sfx:RomPlayz
11.	sbs:Thipit	54.	epo:Tine EP	97.	sfx:Dirt
12.	sbs:LoDowner	55.	epo:The EP	98.	sfx:MoreDirt
13.	bas:Subbin'	56.	epo:Grit EP	99.	sfx:MostDirt
14.	bas:MoogOut	57.	cmp:Wet Clav	100.	sfx:LFOVox
15.	bas:SpitSlap	58.	cmp:WahsUp	101.	hit:MinorVox
16.	bas:Basic	59.	cmp:Jazzed	102.	hit:Dance 3
17.	bas:Finger-O	60.	cmp:Sawcy	103.	hit:FX Slap
18.	bas:Frettnot	61.	cmp:Polysynn	104.	hit:Combo
19.	bas:EP Bass	62.	cmp:PolyMini	105.	hit:GtrSlap
20.	bas:EP Bass2	63.	cmp:PolyWall	106.	hit:BigBand
21.	bas:Slipped	64.	cmp:Polysyn4	107.	gtr:WahNnot?
22.	bas:Jupiters	65.	brs:Wonder	108.	gtr:SwipeHit
23.	bas:Ultimate	66.	brs:HarmChar	109.	gtr:MarleyCk
24.	bas:MonoMan	67.	brs:NonBari	110.	gtr:Lick
25.	bas:Thunder	68.	brs:TrumpHit	111.	gtr:MetalHit
26.	bas:Bakatit	69.	brs:Sax Riff	112.	gtr:Strummer
27.	led:Zingie	70.	brs:Rise	113.	scr:Trails
28.	led:Glider	71.	brs:Fall	114.	scr:Skrachd3
29.	led:Axxel	72.	brs:Swole	115.	scr:Vhocal
30.	led:Sqeelead	73.	syn:Barisyn	116.	prc:PhatSnrs
31.	led:BiggMini	74.	syn:Buzzy B	117.	prc:PhatBds
32.	led:Mini OD	75.	syn:Hallow	118.	prc:PhatPerc
33.	led:Sassy	76.	syn:Dis Axe	119.	prc:PhatBlks
34.	led:Sweepoid	77.	syn:Hanseubl	120.	prc:PhatSnps
35.	led:Digilead	78.	syn:JupiDiss	121.	prc:PhatClps
36.	led:HeavenLd	79.	syn:Krookid	122.	prc:PhatBels
37.	led:Zipworm	80.	syn:Dreemo	123.	prc:PhatHats
38.	led:Calliope	81.	pad:WatRGhst	124.	prc:PhatTbls
39.	gtr:WaFade	82.	pad:WishMakr	125.	prc:PhatBong
40.	gtr:Mutes +	83.	pad:Swirls	126.	prc:SplitKit
41.	gtr:DisThick	84.	pad:PowerOrk	127.	prc:Flexit
42.	org:Shanty	85.	pad:Sunrise		

- | | | |
|------------------|------------------|--------------------|
| 0. sbs:Zopo | 43. cmp:Polysyn5 | 86. hit:BassHit2 |
| 1. sbs:Lopitt | 44. syn:Brssss | 87. gtr:HappySad |
| 2. sbs:Capetbag | 45. syn:Dropping | 88. gtr:Phlanged |
| 3. sbs:Meltdown | 46. syn:Droppng2 | 89. gtr:Bridge |
| 4. bas:Non-Slap | 47. syn:Droppng3 | 90. gtr:Faze Hit |
| 5. bas:Doped | 48. syn:Crowded | 91. gtr:Hit 12 |
| 6. bas:Doped 2 | 49. syn:Voxsteps | 92. gtr:Hit 15 |
| 7. bas:Fingerus | 50. syn:Phander | 93. gtr:Hit 16 |
| 8. bas:Sawzy 5 | 51. syn:Psiance | 94. gtr:Hit 25 |
| 9. bas:Sawzy 6 | 52. syn:SloSci! | 95. scr:Skrachd4 |
| 10. bas:Sawzy 7 | 53. syn:Chicked | 96. scr:Skrachd6 |
| 11. bas:Sawzy 8 | 54. syn:Seq Bell | 97. scr:Skrachd7 |
| 12. bas:Sawzy 9 | 55. syn:Bubbles | 98. scr:Skrachd8 |
| 13. bas:Sawzy 10 | 56. syn:Mosquito | 99. scr:Skrach13 |
| 14. bas:Sawzy 11 | 57. syn:Sublime | 100. scr:Skrach11 |
| 15. bas:Moogy 2 | 58. syn:UnderPad | 101. scr:Skrach15 |
| 16. bas:MorMoogy | 59. syn:MusiCrwd | 102. scr:Blarf |
| 17. bas:Ultibass | 60. syn:Dorothy | 103. scr:BackN4th |
| 18. dbs:Jaa rof | 61. syn:Cool-luv | 104. scr:Ahmm |
| 19. gtr:Guitoo | 62. syn:Dream | 105. scr:Plhuckz |
| 20. gtr:Phaker | 63. syn:Planet | 106. scr:Harder |
| 21. led:WurmHole | 64. vox:EthnoVox | 107. scr:Khordal |
| 22. led:Wormy | 65. vox:She Said | 108. scr:2 Bit |
| 23. led:Fazelead | 66. vox:OhYeaLaf | 109. scr:Dwn Bits |
| 24. led:Shad Up! | 67. vox:Ether | 110. scr:Oh Ohh |
| 25. led:Gwishey | 68. sfx:Skarface | 111. scr:Hardly |
| 26. led:Sys 700 | 69. sfx:Strumbel | 112. scr:CamTalk |
| 27. led:Phlote | 70. sfx:LFOPhatt | 113. scr:Arm Up |
| 28. led:Monica | 71. sfx:E and E | 114. scr:FizzyStx |
| 29. led:Vox Toot | 72. sfx:Oleo | 115. prc:Timbales |
| 30. led:Muteworm | 73. hit:Dance 9 | 116. prc:Blokhead |
| 31. led:Flotzy | 74. hit:HanSoLow | 117. prc:Getkickn |
| 32. led:P5Lead | 75. hit:Dance 1 | 118. prc:Drumrush |
| 33. org:Moody | 76. hit:Dance 2 | 119. prc:Tree |
| 34. org:Odd Job! | 77. hit:Dance 4 | 120. prc:Replay |
| 35. org:GothVox | 78. hit:Dance 5 | 121. prc:Skanky |
| 36. cmp:Muteinet | 79. hit:Dance 6 | 122. prc:Wiggle |
| 37. cmp:Serenade | 80. hit:Dance 7 | 123. prc:Flex Pad |
| 38. cmp:Polysyn6 | 81. hit:Dance 8 | 124. prc:Phased |
| 39. cmp:Polysyn9 | 82. hit:FX 3 | 125. prc:Snares |
| 40. cmp:D'Toon | 83. hit:FX 4 | 126. prc:All Toms |
| 41. cmp:Boinksyn | 84. hit:FX 5 | 127. prc:All Claps |
| 42. cmp:Poly | 85. hit:BassHit1 | |

FACTORY ROM PRESETS - BANK 2

Bank	Contents
0	— 128 RAM Presets
1	— 128 RAM Presets
2	— 128 ROM Presets
3	— 128 ROM Presets
4	— 128 ROM Presets

••• Preset Categories:

bas: .. Bass
bts: .. Used in beats preset
cmp: Comp
epo: .. Electric piano
led: .. Lead instrument
gtr: .. Guitar
hit: ... Orchestra hit
org: .. Organ
pad: .. Thick sustained sound
prc: .. Percussion
rif: Short musical line
sbs: .. Sub bass
scr: ... Record scratch
sfx: ... Sound effect
syn: .. Synthesizer
vox: .. Human voice

0.	<i>sbs:Downeo</i>	43.	<i>led:Zippo</i>	86.	<i>cmp:EepRoll</i>
1.	<i>bas:EPlace</i>	44.	<i>led:Hye Lowe</i>	87.	<i>cmp:GlokMute</i>
2.	<i>led:Bizz TTT</i>	45.	<i>led:Dancer</i>	88.	<i>cmp:Polytown</i>
3..	<i>gtr:Ur Kiss</i>	46.	<i>led:Windworm</i>	89.	<i>cmp:Dirty EP</i>
4.	<i>org:Filteree</i>	47.	<i>led:Minilead</i>	90.	<i>cmp:DirtWave</i>
5.	<i>syn:Phat Pad</i>	48.	<i>led:Scurry</i>	91.	<i>cmp:Philterz</i>
6.	<i>pad:Angelica</i>	49.	<i>led:Phazee</i>	92.	<i>cmp:Lownoise</i>
7.	<i>hit:DanceOn</i>	50.	<i>led:Flatulnt</i>	93.	<i>cmp:Poly'syn</i>
8.	<i>scr:Skratch</i>	51.	<i>led:Urbanize</i>	94.	<i>syn:Cutoff</i>
9.	<i>prc:HiHat It</i>	52.	<i>led:PassedOn</i>	95.	<i>syn:Mood Hit</i>
10.	<i>sbs:WubaDubb</i>	53.	<i>led:Spliffed</i>	96.	<i>syn:LFONo</i>
11.	<i>sbs:Justass</i>	54.	<i>led:JD</i>	97.	<i>syn:FazDream</i>
12.	<i>sbs:Lopitt</i>	55.	<i>led:No Sax!</i>	98.	<i>syn:UnderPad</i>
13.	<i>bas:Ultisub</i>	56.	<i>led:PowrPhat</i>	99.	<i>syn:7th Vox</i>
14.	<i>bas:Soake</i>	57.	<i>led:Belltron</i>	100.	<i>syn:Synbellz</i>
15.	<i>bas:FretFree</i>	58.	<i>led:Leuy Wu</i>	101.	<i>syn:Xyloot</i>
16.	<i>bas:SpitSlap</i>	59.	<i>led:Restron</i>	102.	<i>syn:MoodPhat</i>
17.	<i>bas:EP Bass</i>	60.	<i>led:WaterMuV</i>	103.	<i>syn:PhatFlow</i>
18.	<i>bas:Fatsynbs</i>	61.	<i>led:WishMakr</i>	104.	<i>syn:WormPad</i>
19.	<i>bas:HupRight</i>	62.	<i>led:disWorm</i>	105.	<i>syn:PowerStr</i>
20.	<i>bas:Street</i>	63.	<i>led:AnglHair</i>	106.	<i>syn:PowerEns</i>
21.	<i>bas:Slider</i>	64.	<i>org:OleTimey</i>	107.	<i>syn:ClavPan</i>
22.	<i>bas:Sawzy 1</i>	65.	<i>org:Perky</i>	108.	<i>vox:Spacey</i>
23.	<i>bas:Sawzy 2</i>	66.	<i>org:Swirl</i>	109.	<i>vox:Grunts</i>
24.	<i>bas:Sawzy 3</i>	67.	<i>org:Hi Harm</i>	110.	<i>vox:Yuranis</i>
25.	<i>bas:Moogy 1</i>	68.	<i>org:Grungete</i>	111.	<i>vox:HeGotIt</i>
26.	<i>bas:Moogy 2</i>	69.	<i>org:Low Tick</i>	112.	<i>sfx:TarsGars</i>
27.	<i>bas:Moogy 3</i>	70.	<i>org:SlowSpin</i>	113.	<i>sfx:Flex</i>
28.	<i>bas:BigSaw</i>	71.	<i>org:Voxey</i>	114.	<i>sfx:InTheGrv</i>
29.	<i>bas:Bigmoog</i>	72.	<i>org:Voxhit</i>	115.	<i>sfx:LSD</i>
30.	<i>bas:Bigmoog2</i>	73.	<i>brs:Mutefret</i>	116.	<i>sfx:OleTimes</i>
31.	<i>bas:Bigmoog3</i>	74.	<i>brs:Stevie</i>	117.	<i>sfx:RomPhatt</i>
32.	<i>bas:Filtoy</i>	75.	<i>brs:Harmonia</i>	118.	<i>hit:Musica</i>
33.	<i>bas:Boink</i>	76.	<i>brs:BrasKord</i>	119.	<i>hit:Voxit</i>
34.	<i>bas:Oowww</i>	77.	<i>brs:Sinbrass</i>	120.	<i>hit:BrassAge</i>
35.	<i>gtr:Conway</i>	78.	<i>brs:Boink</i>	121.	<i>hit:PhatHits</i>
36.	<i>gtr:KikStart</i>	79.	<i>cmp:ClavenIt</i>	122.	<i>hit:PhatGtrs</i>
37.	<i>gtr:PhatFedr</i>	80.	<i>cmp:Wirlibid</i>	123.	<i>hit:Phat Fx</i>
38.	<i>gtr:Krunge</i>	81.	<i>cmp:EPeazy</i>	124.	<i>hit:Brass</i>
39.	<i>gtr:Fif</i>	82.	<i>cmp:Rodezy</i>	125.	<i>rif:Blk Jett</i>
40.	<i>gtr:MuTrahn</i>	83.	<i>cmp:Rolled</i>	126.	<i>rif:Stealy Z</i>
41.	<i>gtr:Spooky</i>	84.	<i>cmp:Polysensi</i>	127.	<i>rif:FripRTrn</i>
42.	<i>gtr:Mutes</i>	85.	<i>cmp:Hiss Man</i>		

- | | | |
|------------------|--------------------|-------------------|
| 0. rif:ThomThum | 43. bas:BlipBaz5 | 86. gtr:Slider |
| 1. rif:QweeXhum | 44. bas:EP Bass | 87. gtr:DimStrum |
| 2. rif:PhoneCal | 45. bas:Basasalt | 88. gtr:Whah |
| 3. scr:PhatScrs | 46. bas:Ultimate | 89. hit:Whakt |
| 4. scr:Skrach10 | 47. bas:Ultima2 | 90. hit:Drisbitt |
| 5. scr:Skrachd | 48. gtr:Growl | 91. hit:PhatDanz |
| 6. scr:Skreem | 49. gtr:Growl2 | 92. hit:KhylaTue |
| 7. scr:Skrachd5 | 50. led:Trumclav | 93. hit:TangaToe |
| 8. prc:Kix | 51. led:Clartron | 94. hit:QandaVaz |
| 9. prc:Snares | 52. led:BlipSlip | 95. scr:ButrCrem |
| 10. prc:Bells | 53. led:Blip 2 | 96. scr:GoonSquad |
| 11. prc:Blocks | 54. led:Blip 3 | 97. scr:BackScrz |
| 12. prc:DopePerc | 55. led:Harmonizin | 98. prc:Plush |
| 13. prc:Scratchd | 56. led:JazSplit | 99. prc:Wiped |
| 14. prc:PhatrHat | 57. led:Trumpbel | 100. prc:Rerun |
| 15. prc:PhatCyms | 58. led:Troompet | 101. prc:Skary |
| 16. prc:PhatBels | 59. cmp:EPee 1 | 102. prc:Cushion |
| 17. prc:PhatTams | 60. cmp:Wrodes | 103. prc:Wrapped |
| 18. prc:PhatToms | 61. cmp:Bellza | 104. prc:Phased |
| 19. prc:PhatShks | 62. cmp:Syntho | 105. bts:Game 1 |
| 20. sbs:Booty | 63. cmp:Xylitzer | 106. bts:Speed |
| 21. bas:SoloMan | 64. cmp:Krouded | 107. bts:Swingin' |
| 22. bas:SlapIt | 65. cmp:Douser | 108. bts:Chill |
| 23. bas:BigSaw 2 | 66. cmp:fogAdirt | 109. bts:Deep |
| 24. bas:BigSaw 3 | 67. brs:Lo&Dirty | 110. bts:Working |
| 25. bas:BigSaw 4 | 68. pad:SubCrowd | 111. bts:Check It |
| 26. bas:Bigmoog1 | 69. pad:UpStairs | 112. bts:Graf |
| 27. bas:Gitter | 70. pad:DlbHeadr | 113. bts:GrvReady |
| 28. bas:Thumbby | 71. pad:DreamOn | 114. bts:Bunch |
| 29. bas:Whomp | 72. pad:BigStrng | 115. bts:Say What |
| 30. bas:Tempest | 73. pad:Mulatron | 116. bts:System |
| 31. bas:Shinya | 74. sfx:Effex Ya | 117. bts:Dope |
| 32. bas:Nasstee | 75. sfx:Trix Ya | 118. bts:Talking |
| 33. bas:Vango | 76. sfx:SpakDirt | 119. bts:And How |
| 34. bas:SlamTime | 77. sfx:Hal 999 | 120. bts:Smooth |
| 35. bas:RuberRez | 78. sfx:TronDite | 121. bts:IntheAir |
| 36. bas:Quaszy | 79. sfx:Distonit | 122. bts:Phattttt |
| 37. bas:Res-Sine | 80. sfx:Juicy Q | 123. bts:Phun |
| 38. bas:T-CatchR | 81. sfx:Released | 124. bts:Phunky |
| 39. bas:BlipBazz | 82. sfx:Ofaji | 125. bts:4 Real |
| 40. bas:BlipBaz2 | 83. hit:Whisk | 126. bts:Box |
| 41. bas:BlipBaz3 | 84. hit:Ahoy | 127. bts:State |
| 42. bas:BlipBaz4 | 85. hit:Bonk | |

FACTORY ROM PRESETS - BANK 4

Bank	Contents
0	— 128 RAM Presets
1	— 128 RAM Presets
2	— 128 ROM Presets
3	— 128 ROM Presets
4	— 128 ROM Presets

••• Preset Categories:

bas: .. Bass
bts: .. Used in beats preset
cmp: Comp
epo: .. Electric piano
led: .. Lead instrument
gtr: .. Guitar
hit: ... Orchestra hit
org: .. Organ
pad: .. Thick sustained sound
prc: .. Percussion
rif: Short musical line
sbs: .. Sub bass
scr: ... Record scratch
sfx: ... Sound effect
syn: .. Synthesizer
vox: .. Human voice

- | | | | | | |
|-----|----------------------|-----|---------------------|------|---------------------|
| 0. | <i>bts:Blow Up</i> | 43. | <i>bts:Passit2U</i> | 86. | <i>bts:Got It</i> |
| 1. | <i>bts:Row</i> | 44. | <i>bts:Meaty</i> | 87. | <i>bts:Betta</i> |
| 2. | <i>bts:Shorty's</i> | 45. | <i>bts:Sweet</i> | 88. | <i>bts:Dry Wood</i> |
| 3. | <i>bts:Foxy</i> | 46. | <i>bts:PhatFaze</i> | 89. | <i>bts:HardWood</i> |
| 4. | <i>bts:Mobb</i> | 47. | <i>bts:Space</i> | 90. | <i>bts:GiveItUp</i> |
| 5. | <i>bts:Lunar</i> | 48. | <i>bts:Revva</i> | 91. | <i>bts:Flavor</i> |
| 6. | <i>bts:Kontrol</i> | 49. | <i>bts:Revva 2</i> | 92. | <i>bts:Laurel</i> |
| 7. | <i>bts:Kit</i> | 50. | <i>bts:Mee2</i> | 93. | <i>bts:Nu Jak</i> |
| 8. | <i>bts:Farm</i> | 51. | <i>bts:OleSkool</i> | 94. | <i>bts:Brass</i> |
| 9. | <i>bts:Vapor</i> | 52. | <i>bts:BoomBip</i> | 95. | <i>bts:Copper</i> |
| 10. | <i>bts:Space</i> | 53. | <i>bts:Cruzin'</i> | 96. | <i>bts:Zink</i> |
| 11. | <i>bts:KikLoc</i> | 54. | <i>bts:DaDirty</i> | 97. | <i>bts:Steel</i> |
| 12. | <i>bts:Cool</i> | 55. | <i>bts:GetFunky</i> | 98. | <i>bts:Potash</i> |
| 13. | <i>bts:Sensi</i> | 56. | <i>bts:Get Up</i> | 99. | <i>bts:Iron</i> |
| 14. | <i>bts:Rude</i> | 57. | <i>bts:Ole Days</i> | 100. | <i>bts:Lithium</i> |
| 15. | <i>bts:Test It</i> | 58. | <i>bts:WitHelp</i> | 101. | <i>bts:Platinum</i> |
| 16. | <i>bts:Pocket</i> | 59. | <i>bts:Busy</i> | 102. | <i>bts:Gold</i> |
| 17. | <i>bts:Peeps</i> | 60. | <i>bts:IllMatic</i> | 103. | <i>bts:Silver</i> |
| 18. | <i>bts:BigUp</i> | 61. | <i>bts:ISawU</i> | 104. | <i>bts:Joint</i> |
| 19. | <i>bts:Happy</i> | 62. | <i>bts:LARide</i> | 105. | <i>bts:Blunted</i> |
| 20. | <i>bts:Drumm</i> | 63. | <i>bts:Leavin'</i> | 106. | <i>bts:Fly</i> |
| 21. | <i>bts:Perky</i> | 64. | <i>bts:OohYeah</i> | 107. | <i>bts:Fly Ltd</i> |
| 22. | <i>bts:Sloe</i> | 65. | <i>bts:PPPhatt</i> | 108. | <i>bts:Chronic</i> |
| 23. | <i>bts:Ice</i> | 66. | <i>bts:Ragga</i> | 109. | <i>bts:Buggin</i> |
| 24. | <i>bts:ReddHot</i> | 67. | <i>bts:Remember</i> | 110. | <i>bts:RUNdaGrv</i> |
| 25. | <i>bts:Down</i> | 68. | <i>bts:Spice It</i> | 111. | <i>bts:Urb</i> |
| 26. | <i>bts:Juicy</i> | 69. | <i>bts:StillZon</i> | 112. | <i>bts:Split 1</i> |
| 27. | <i>bts:It</i> | 70. | <i>bts:UKnew</i> | 113. | <i>bts:Split 2</i> |
| 28. | <i>bts:On</i> | 71. | <i>bts:WestUp</i> | 114. | <i>bts:Split 3</i> |
| 29. | <i>bts:Off</i> | 72. | <i>bts:Wicked</i> | 115. | <i>bts:Split 4</i> |
| 30. | <i>bts:Skillz</i> | 73. | <i>bts:UTrip</i> | 116. | <i>bts:Split 5</i> |
| 31. | <i>bts:Metro</i> | 74. | <i>bts:Yukka</i> | 117. | <i>bts:Split 6</i> |
| 32. | <i>bts:Zombie</i> | 75. | <i>bts:Zonin'</i> | 118. | <i>bts:Split 7</i> |
| 33. | <i>bts:Wacked</i> | 76. | <i>bts:Combo</i> | 119. | <i>bts:Split 8</i> |
| 34. | <i>bts:Not Only</i> | 77. | <i>bts:Deluxe</i> | 120. | <i>bts:Split 9</i> |
| 35. | <i>bts:OutaSpace</i> | 78. | <i>bts:Bomb</i> | 121. | <i>bts:Split10</i> |
| 36. | <i>bts:Trip</i> | 79. | <i>bts:Freestyl</i> | 122. | <i>bts:Split11</i> |
| 37. | <i>bts:Assault!</i> | 80. | <i>bts:Playa</i> | 123. | <i>bts:Split12</i> |
| 38. | <i>bts:Ill</i> | 81. | <i>bts:Tasty</i> | 124. | <i>bts:Split13</i> |
| 39. | <i>bts:Bangin'</i> | 82. | <i>bts:G-Funk</i> | 125. | <i>bts:Split14</i> |
| 40. | <i>bts:Slammin'</i> | 83. | <i>bts:Big Up</i> | 126. | <i>bts:Split15</i> |
| 41. | <i>bts:Killa</i> | 84. | <i>bts:Props</i> | 127. | <i>-default-</i> |
| 42. | <i>bts:Busta</i> | 85. | <i>bts:Droppin'</i> | | |

001. SE Sub 1	034. Ultimate 2b	067. ElectriWorm
002. SE Sub 2	035. BigSaw Bass	068. Electron
003. SE Sub 3	036. BigMoogSaw1	069. Tone Organ
004. SE Sub 4	037. BigMoogSaw2	070. Disco Organ
005. SE Sub 5	038. Mini Moog	071. DX Organ
006. SE Sub 6	039. Filter Bass	072. JX Organ
007. SE Sub 7	040. Fat SynBass	073. Oddd Organ
008. SE Sub 8	041. Jupiter Bass	074. Clavinet
009. SE Sub 9	042. Syn Tone	075. Wurlitzer
010. SE Sub 10	043. BassBalls1	076. FM EP 1a
011. SE Sub 11	044. BassBalls2	077. FM EP 1b
012. Subtle Bass	045. Bas Boy Syn	078. Tine EP
013. Bass Slap 1	046. All Purpose	079. Rhodes
014. Bass Slap 2	047. Standard	080. EP Fog
015. FingerBass1	048. Buzz Bass	081. EP Roll1 C
016. FingerBass2	049. Home Bass	082. EP Roll2 F6
017. E P Bass 1	050. Gtr Mutes	083. EP Roll3Bbm
018. E P Bass 2a	051. Sine Wave	084. HarmonTpt
019. E P Bass 2b	052. Saw Wave	085. Harmon FX 1
020. UprightBass	053. Synth Axe 1	086. Harmon FX 2
021. Fretless 1	054. Synth Axe 2	087. Bari Wave
022. Fretless 2	055. Zippy Lead	088. P5 Brass
023. Fretless 3	056. Mini OD2	089. Spacy Tpt
024. Fretless 4	057. Bell Synth	090. Sax Riff Eb
025. Street Bass	058. BuzzSynth 1	091. WackTptC#m7
026. TBazz	059. BuzzSynth 2	092. Synth Flute
027. Dope Bass 1	060. Dance Lead	093. Boink
028. Dope Bass 2	061. Worm Lead 1	094. Brass Bb
029. DopeBassHit	062. Worm Lead 2	095. Harmonica
030. Slider Bass	063. Worm Lead 3	096. Gtr Wah Bm
031. Saw Bass	064. Worm Lead 4	097. Alt Gtr Wah
032. Moog Saw	065. Worm Lead 5	098. DisTar Pad
033. Ultimate 2a	066. Worm Lead 6	099. SynthHiStrg

INSTRUMENT LISTING

100. SynthEnsble	133. Snares	166. GtrHit4 D
101. Synth Vox	134. Toms	167. GtrHit5 Bm
102. Jupiter Syn	135. Timbales	168. GtrHit6 F
103. MoodStrings	136. CongasBngos	169. GtrHit7 E
104. Xylo Pad	137. Hats	170. GtrHit8 F#
105. Jupiter	138. Cymbals	171. GtrHit9
106. Dreamyy C	139. Shakers	172. GtrHit10
107. Phat Pad	140. Bells	173. GtrHit11 D#
108. UnderPad Fm	141. Blocks	174. GtrHit12 Am
109. Science	142. Tams	175. GtrHit13 E
110. MusiCrowd	143. Claps	176. GtrHit14 G
111. Crowd 2	144. Snaps	177. GtrHit15
112. Crowd 2 NTP	145. Misc Perc	178. GtrHit16 D
113. Dirt 1	146. DanceHit1 E	179. GtrHit17 G
114. Dirt NTP	147. DanceHit2F#	180. GtrHit18 A
115. Dirt 2	148. DanceHit3G#	181. GtrHit19
116. Dirt 2 NTP	149. DanceHt4C#m	182. GtrHit20 D#
117. Dirt 3	150. DanceHit5C#	183. GtrHit21
118. Dirt 3 NTP	151. DanceHit6 G	184. GtrHit22 F#
119. Oow	152. DanceHit7Gm	185. GtrHit23
120. Soul Oohs	153. DanceHit8 A	186. GtrHit24
121. Dance Hits	154. DanceHit9 D#	187. GtrHit25 A7
122. FX Hits	155. DanceHt10Cm	188. GtrHit26 D
123. Gtr Riffs	156. FX Hit1	189. GtrHit27
124. Bass Hits 1	157. FX Hit2	190. GtrHit28 A
125. Bass Hits 2	158. FX Hit3 F#m	191. GtrHit29 F7
126. Brass Hits	159. FX Hit4 F#	192. GtrHit30A#m
127. Vox Hits1	160. FX Hit5	193. Bass Hit1
128. Vox Hits 2	161. FX Hit6 E	194. Bass Hit2
129. Scratches	162. FX Hit7 B	195. Bass Hit3
130. ScrtchLoops	163. GtrHit1 D#s	196. Bass Hit4
131. ScratchBits	164. GtrHit2 D	197. BassHit5
132. Kicks	165. GtrHit3 F	198. Tpt FX 1

199. Tpt FX 2	232. Scratch 4	265. Kick 20
200. Tpt FX 3	233. Scratch 5	266. Kick 21
201. Tpt FX 4	234. Scratch 6	267. Kick 22
202. Tpt FX 5	235. Scratch 7	268. Kick 23
203. Sax FX 1	236. Scratch 8	269. Kick 24
204. Sax FX 2	237. Scratch 9	270. Kick 25
205. Brs Hit1Bbm	238. Scratch 10	271. Kick 26
206. Brs Hit2	239. Scratch 11	272. Kick 27
207. Brs Hit3 F#	240. Scratch 12	273. Kick 28
208. Brs Hit4 D#	241. Scratch 13	274. Kick 29
209. Brs Hit5 D#	242. Scratch 14	275. Kick 30
210. Brs Hit6	243. Scratch 15	276. Snare 1
211. Brs Hit7 C	244. Scratch 16	277. Snare 2
212. Brs Hit8 G	245. Scratch 17	278. Snare 3
213. Brs Hit9	246. Kick 1	279. Snare 4
214. Brs Ht10 E7	247. Kick 2	280. Snare 5
215. Brs Hit11 B	248. Kick 3	281. Snare 6
216. Brs Ht12 G#	249. Kick 4	282. Snare 7
217. Brs Ht13A#m	250. Kick 5	283. Snare 8
218. Brs Hit14	251. Kick 6	284. Snare 9
219. Brs Ht15 G#	252. Kick 7	285. Snare 10
220. Brs Ht16 G#	253. Kick 8	286. Snare 11
221. Brs Hit17 D	254. Kick 9	287. Snare 12
222. Brs Hit18 A	255. Kick 10	288. Snare 13
223. Vox Hit 1	256. Kick 11	289. Snare 14
224. Vox Hit 2	257. Kick 12	290. Snare 15
225. Vox Hit 3	258. Kick 13	291. Snare 16
226. Vox Hit 4	259. Kick 14	292. Snare 17
227. Vox Hit 5	260. Kick 15	293. Snare 18
228. Vox Hit 6	261. Kick 16	294. Snare 19
229. Scratch 1	262. Kick 17	295. Snare 20
230. Scratch 2	263. Kick 18	296. Snare 21
231. Scratch 3	264. Kick 19	297. Snare 22

INSTRUMENT LISTING

298. Snare 23	331. Snare 55	364. Hat 8
299. Snare 24	332. Snare 56	365. Hat 9
300. Snare 25	333. Snare 57	366. Hat 10
301. Snare 26	334. Snare 58	367. Hat 11
302. Snare 27	335. Snare 59	368. Hat 12
303. Snare 28	336. Snare 60	369. Hat 13
304. Snare 29	337. Snare 61	370. Hat 14
305. Snare 30	338. Tom 1	371. Hat 15
306. Snare 31	339. Tom 2	372. Hat 16
307. Snare 32	340. Tom 3	373. Hat 17
308. Snare 33	341. Tom 4	374. Hat 18
309. Snare 33b	342. Tom 5	375. Hat 19
310. Snare 34	343. Tom 6	376. Hat 20
311. Snare 35	344. Tom 7	377. Hat 21
312. Snare 36	345. Tom 8	378. Hat 22
313. Snare 37	346. Tom 9	379. Hat 23
314. Snare 38	347. Timbale 1	380. Hat 24
315. Snare 39	348. Timbale 2	381. Hat 25
316. Snare 40	349. Conga 1	382. Hat 26
317. Snare 41	350. Conga 2	383. Hat 27
318. Snare 42	351. Conga 3	384. Hat 28
319. Snare 43	352. Conga 4	385. Hat 29
320. Snare 44	353. Conga 5	386. Hat 30
321. Snare 45	354. Conga 6	387. Hat 31
322. Snare 46	355. Conga 7	388. Hat 32
323. Snare 47	356. Bongo 1	389. Hat 33
324. Snare 48	357. Hat 1	390. Cymbal 1
325. Snare 49	358. Hat 2	391. Cymbal 2
326. Snare 50	359. Hat 3	392. Cymbal 3
327. Snare 51	360. Hat 4	393. Cymbal 4
328. Snare 52	361. Hat 5	394. Cymbal 5
329. Snare 53	362. Hat 6	395. Cymbal 6
330. Snare 54	363. Hat 7	396. Cymbal 7

397. Cymbal 8	430. Bell 12	463. Misc Perc 2
398. Cymbal 9	431. Bell 13	464. Misc Perc 3
399. Cymbal 10	432. Block 1	465. Misc Perc 4
400. Cymbal 11	433. Block 2	466. Misc Perc 5
401. Cymbal 12	434. Block 3	467. Misc Perc 6
402. Shaker 1	435. Block 4	468. Misc Perc 7
403. Shaker 2	436. Block 5	469. Misc Perc 8
404. Shaker 3	437. Block 6	470. Misc Perc 9
405. Shaker 4	438. Tam 1	471. Kit 1
406. Shaker 5	439. Tam 2	472. Kit 2
407. Shaker 6	440. Tam 3	473. Kit 3
408. Shaker 7	441. Tam 4	474. Kit 4
409. Shaker 8	442. Tam 5	475. Kit 5
410. Shaker 9	443. Clap 1	476. Kit 6
411. Shaker 10	444. Clap 2	477. Kit 7
412. Shaker 11	445. Clap 3	478. Kit 8
413. Shaker 12	446. Clap 4	479. Kit 9
414. Shaker 13	447. Clap 5	480. Kit 10
415. Shaker 14	448. Clap 6	481. Rom Play
416. Shaker 15	449. Clap 7	
417. Shaker 16	450. Clap 8	
418. Shaker 17	451. Clap 9	
419. Bell 1	452. Clap 10	
420. Bell 2	453. Clap 11	
421. Bell 3	454. Clap 12	
422. Bell 4	455. Scraa	
423. Bell 5	456. Snap 1	
424. Bell 6	457. Snap 2	
425. Bell 7	458. Snap 3	
426. Bell 8	459. Snap 4	
427. Bell 9	460. Snap 5	
428. Bell 10	461. Snap 6	
429. Bell 11	462. Misc Perc 1	

BEAT KIT 1

Kick 17 (Electronic)	28		
Kick 17 (Electronic)	29	██████████	Kick 17 (Electronic)
Kick 17 (Electronic)	31	██████████	Kick 17 (Electronic)
Kick 17 (Electronic)	33	██████████	Kick 17 (Electronic)
Kick 17 (Electronic)	35	██████████	
Kick 17 (Electronic)	36	██████████	
Snare 27	38	██████████	Snare 35 (Hollow)
Scratch 9	40	██████████	Tom 5
Tom 6 (Low)	41	██████████	
Tom 6 (Mid 1)	43	██████████	Hi Hat 13 (Mid)
Tom 3 (Mid 2)	45	██████████	Hi Hat 14 (Closed)
Tom 3 (High)	47	██████████	Hi Hat 13 (Mid)
Kick 29 (Tite)	48	██████████	
Snare 19 (Rim)	50	██████████	Snare 10 (Brush)
Snare 9 (Brush)	52	██████████	Hi Hat 1 (Closed)
Tom 2 (Brush Low)	53	██████████	
Tom 2 (Brush Mid)	55	██████████	Hi Hat 9 (Mid)
Tom 2 (Brush High)	57	██████████	Hi Hat 10 (Brush)
Cymbal 10 (Ride)	59	██████████	Hi Hat 11 (Open)
Kick 12 (Jungle)	60C3	██████████	
Snare 29 (Jungle)	62	██████████	Snare 6 (Rim)
Snare 23	64	██████████	Hi Hat 7 (open/Closed)
Finger Snap 2	65	██████████	
Finger Snap 3	67	██████████	Hi Hat 16 (Closed Tip)
Clap 5	69	██████████	Hi Hat 17 (Semi)
Tambourine 1	71	██████████	Hi Hat 32 (Open Tip)
Kick 11 (R&B)	72	██████████	
Snare 34 (R&B)	74	██████████	Snare 2 (Stick)
Snare 33 (Buzz Roll)	76	██████████	Snare 31 (R&B)
Snare 33 (Buzz Roll)	77	██████████	
Tom 9 (R&B)	79	██████████	Hi Hat 8 (Closed Electronic)
Tom 9 (R&B)	81	██████████	Hi Hat 6 (Open Electronic)
Kick 15 (Rap)	83	██████████	Cymbal 2 (Rap Ride)
Kick 16 (Rap)	84	██████████	
Snare 61 (Rap)	86	██████████	Cymbal 2 (Rap)
Snare 58 (Rap)	88	██████████	Snare 37 (Rap)
Brass Hit 12	89	██████████	
Brass Hit 12	91	██████████	Brass Hit 12
Brass Hit 12	93	██████████	Brass Hit 12
Brass Hit 12	95	██████████	Brass Hit 12
Brass Hit 12	96	██████████	
Brass Hit 12	98	██████████	Brass Hit 12
Brass Hit 12	100	██████████	Brass Hit 12
Brass Hit 12	101	██████████	
Brass Hit 12	103	██████████	Brass Hit 12
Brass Hit 12	105	██████████	Brass Hit 12
Brass Hit 12	107	██████████	Brass Hit 12
Brass Hit 12	108	██████████	

	↑	
Kick 2 (Sine)	28	
Kick 2 (Sine)	29	Kick 2 (Sine)
Kick 2 (Sine)	31	Kick 2 (Sine)
Kick 2 (Sine)	33	Kick 2 (Sine)
Kick 2 (Sine)	35	Kick 2 (Sine)
Kick 10	36	
Snare 15	38	Snare 1 (Rim)
Scratch 9	40	Hand Clap 1
Tom 6	41	
Tom 2 (Brush)	43	Hi Hat 2 (Closed)
Tom 9 (R&B)	45	Hi Hat 3 (Foot)
Tom 3	47	Hi Hat 4 (Open/Closed)
Tom 2 (Brush)	48	
Tom 3 (Roto)	50	Cymbal 4 (Crash)
Cymbal 11 (Ride)	52	Cymbal 5 (Ride)
Cymbal 8 (Ride)	53	
Cymbal 1 (Splash)	55	Tambourine 2
Cymbal 3 (Crash)	57	Bell 12 (Cowbell)
Cymbal 7 (Ride)	59	Shaker 14
Bongo 1	60C3	
Conga 6	62	Bongo 1
Conga 3	64	Conga 7 (Slap)
Timbale 2	65	
Bell 1 (Cowbell)	67	Timbale 1
Shaker 6	69	Bell 9 (Cowbell)
Bell 1	71	Shaker 7 (Maraca)
bell 2 (Flexitone)	72	
Shaker 10	74	Shaker 12
Block 1	76	Block 3 (Clave)
Block 5	77	
Hand Clap 3	79	FX Hit 5
Bell 4 (Triangle Open)	81	Bell 3 (Triangle Closed)
Bell 5 (Sleigh Bells)	83	Shaker 4
Bell 3 (BellTree)	84	
Scratch 7	86	Scratch 6
Vox Hit 4 (Female Laugh)	88	Gtr Hit 27
Vox Hit 6 (Male Laugh)	89	
Scraa (FX)	91	Brass Hit 5
Brass Hit 17	93	Sax FX 2 (Squeal)
UnderPad	95	UnderPad
UnderPad	96	
Gtr Hit 19	98	Gtr Hit 19
Spacy Trumpet	100	Spacy Trumpet
Spacy Trumpet	101	
Spacy Trumpet	103	Spacy Trumpet
Spacy Trumpet	105	Spacy Trumpet
Spacy Trumpet	107	Spacy Trumpet
Spacy Trumpet	108	

BEAT KIT 5

Kick 17	23	
Kick 16	24	
Snare 52	26	Kick 17
Snare 52	28	Kick 17
Tom 3	29	
Tom 3	31	Cymbal 2
Tom 3	33	Cymbal 2
Kick 17 (Electronic)	35	Cymbal 4
Kick 21	36	
Snare 56	38	Kick 5
Snare 56	40	Kick 6
Scratch 9	41	
Tom 6	43	Hi Hat 16 (Closed Tip)
Tom 6	45	Hi Hat 15 (Pedal Closed)
Tom 6	47	Hi Hat 32 (Open Tip)
Kick 28	48	
Snare 16	50	Dirt 2 (Record Noise)
Snare 8 (Brushes)	52	Block 4
Snare 9 (Brushes)	53	
Tom 2 (Brush Low)	55	Hat 11
Tom 2 (Brush High)	57	Hi Hat 10 (Brush)
Cymbal 3 (Ride)	59	Shaker 3
Kick 12 (Jungle)	60C3	
Snare 29 (Jungle)	62	Snare 30
Snare 23	64	Hi Hat 26
Bell 4 (Chimes)	65	
Cymbal 2	67	Tambourine 4
Hand Clap 5	69	Scraa
Tambourine 1	71	Bass Hit 2
Kick 4 (Electronic)	72	
Snare 34 (R&B)	74	Snare 56
Snare 33 (Buzz Roll)	76	Snare 56
Scratch 17	77	
Tom 9 (R&B)	79	Hat 8 (Closed Electronic)
Tom 9 (R&B)	81	Hat 6 (Open Electronic)
Kick 15 (Rap)	83	Cymbal 2 (Rap Ride)
Kick 16 (Rap)	84	
Snare 13 (Rap)	86	Cymbal 4 (Crash)
Scraa (FX)	88	Gtr Hit 23
Brass Hit 13	89	
Vox Hit 3	91	Brass Hit 6
FX Hit 2	93	Oow
Music Crowd	95	Science
Guitar Hit 22	96	
Tambourine 2	98	Scratch 4
Scraa (FX)	100	Misc Perc 4
Scratch 5	101	
Cymbal 2	103	Hi Hat 5
Block 6	105	Hi Hat 22
Timbale 2	107	Hat 27
Timbale 1	108	

Audio Channels: 32

Audio Outputs: 6 (2 main, 4 submix)

Submix Inputs: 4

Max. Output Level: +4 dBv

Output Impedance: 1K Ω

MIDI: In, Out, Thru

Data Encoding: 16 bit linear data, 18 bit linear outputs

Sample Playback Rate: 39 kHz

Signal to Noise: >90 dB

Dynamic Range: >90 dB

Frequency Response: 20 Hz-15 kHz

THD +N: <.05%

IMD: <.05%

Stereo Phase: Phase Coherent $\pm 1^\circ$ at 1 kHz

Power Requirements: 25 watts

Dimensions: H: 1.75" W: 19" L: 8.5"

Weight: 6 lb, 14 oz (3.1 Kg)

MIDI IMPLEMENTATION CHART

Function...	Transmitted	Recognized	Remarks
Basic Channel Default Changed	No No	1 1-16	Memorized
Mode Default Messages	No	Mode 1, 3, 4 MONO, POLY OMNI, ON/OFF	Memorized
Note Number True Voice	No No	0-127 0-127	
Velocity Note ON Note OFF	No No	Yes v=1-127 No	
After Touch Keys Channels	No No	Yes Yes	
Pitch Bender	No	Yes	
Control Change	No	Yes	0-31 64-79
Bank Select	No	Yes	
Program Change True Number	No No	Yes 0-127 Yes 0-127	
All Sound Off	No	Yes	
All Notes Off	No	Yes	
Reset All Controllers	No	Yes	
System Exclusive	Yes	Yes	
System Common :Song Pos :Song Sel :Tune	No No No	No Yes No	Song Sel - F3 ss 0-99 = Beats 100-127 = Songs
System Real Time :Clock :Commands	No No	Yes Yes	Beats Mode Only
Aux Messages :Local On/Off :Active Sense :Reset	No No No	No No No	
<p>Notes: Pan 0=hard left 127=hard right Song Select is only enabled when the Beats mode screen is showing in the display. Mode 1: OMNI ON, POLY Mode 2: OMNI ON, MONO Mode 3: OMNI OFF, POLY Mode 4: OMNI OFF, MONO</p>			

GENERAL INFORMATION FOR PLANET PHATT SYSEX

- Product ID for Planet Phatt is **0A**.
- Device ID is [00-0F] (0-15 decimal).
- Parameter Number and Parameter Value are 2 bytes each.
- Since MIDI data bytes cannot be greater than [7F] (127 decimal), the data values are “nibble-ized” to a 14-bit signed 2's complement format.
- There is only one edit buffer which is for the current preset (the preset shown in the display). Only one preset at a time can be edited via SysEx commands and changing the current preset erases the edit buffer.

RECEIVED CHANNEL COMMANDS

Channels number (n) = 0-15. Message bytes are represented in hex. All other numbers are decimal. Running Status is supported.

<i>Command</i>	<i>Message</i>	<i>Comments</i>
Note Off	8n kk vv	release velocity is ignored
Note On	9n kk vv	velocity 0 = note off
Key Aftertouch	An kk vv	kk = 0-127 vv = 0-127
Program Change	Cn vv	vv = 0-127
Channel Aftertouch	Dn vv	vv = 0-127
Pitch Bend	En ll mm	l = lsb, m = msb
Realtime Controller	Bn cc vv	cc = 00-31, vv = 0-127
Footswitch	Bn cc vv	cc = 64-79, vv ≥ 64 = on
Volume	Bn 07 vv	vv = 0-127
Pan	Bn 0A vv	0=left, 127=right, 64=center
All Sound Off	Bn 78 00	turns all sound off
Reset All Controllers	Bn 79 00	ignored in omni mode
All Notes Off	Bn 7B 00	ignored in omni mode
Omni Mode Off*	Bn 7C 00	forces all notes & controls off
Omni Mode On*	Bn 7D 00	forces all notes & controls off
Mono Mode On (Poly Off)*	Bn 7E 00	forces all notes & controls off
Poly Mode On (Mono Off)*	Bn 7F 00	forces all notes & controls off
Bank Select	Bn 00 00 20 bb	bb = bank #

••• *Running Status is supported in Planet Phatt.*

* Special Notes:

From Omni Mode ... Omni Off turns Poly On.

From Poly Mode Omni On turns Omni On; Mono On turns Mono On.

From Mono Mode ... Mono Off turns Poly On; Omni On turns Omni On.

From Multi Mode ... Omni On turns Omni On; Omni Off or Mono Off turns Poly On; Mono On turns Mono On.

All other changes have no effect.

••• Planet Phatt will receive Proteus presets, but will fill in the extra parameters with default values and set instruments to "None".

▼ There is only one edit buffer which is for the current preset (the preset shown in the display). Only one preset at a time can be edited via SysEx commands and changing the current preset erases the edit buffer.

MIDI SYSEX COMMANDS

For system exclusive commands, the following format is used:

F0	system exclusive status byte
18	E-mu ID byte
0A	product ID byte (<i>will also respond to ID 04 - Proteus</i>)
dd	device ID byte
cc	command byte
...	data bytes
F7	EOX

SysEx Editing

Preset and setup parameters may be edited individually using system exclusive commands. The preset being edited is the active preset (the preset on the basic or global channel and the one which is shown in the LCD). The value of a given parameter may be changed by sending a *parameter value* command. The value of a parameter may be read by sending a *parameter value request*, to which the machine will respond by sending back the parameter value.

Two MIDI bytes (lsb, msb) are required for each 14 bit data word. Bits 0-6 are sent first, followed by bits 7-13 in the next MIDI byte. All data words are signed 2's complement values with sign-extension out to the most significant bit (bit 13). This convention applies to all data words, regardless of the parameter's value range.

Preset data may also be transmitted or received in a single block (one complete preset) using system exclusive commands. A *preset data request* may be issued by a host computer, to which the machine will respond sending the data block for the requested preset. Conversely, the computer may send new preset data which will replace the specified preset currently in the machine. Additionally, a front panel command will transmit one or all user presets for backup onto an external sequencer. These presets may be restored by simply playing back the sequence into the machine.

Warning: When transferring preset banks and tuning table data back and forth from Planet Phatt to a computer, the data should be recorded as you would a regular sequence. Sending the data in one huge chunk will clog the input buffer on Planet Phatt unless a time period of approximately 100 mS is inserted between each preset.

RECEIVED SYSTEM EXCLUSIVE COMMANDS

<i>Command</i>	<i>Message</i>	<i>Comments</i>
Preset Data Request	F0 18 0A dd 00 ll mm F7 <i>see note 6</i>	ll= preset # lsb mm = msb
Preset Data	F0 18 0A dd 01 ll mm cs F7 <i>cs=checksum</i>	
Parameter Value Request	F0 18 0A dd 02 pl pm F7 <i>pl = parameter # lsb pm = msb</i>	
Parameter Value	F0 18 0A dd 03 pl pm vl vm F7 <i>pl = parameter # lsb pm = msb vl = value lsb vm = msb</i>	
Tuning Table Request	F0 18 0A dd 04 F7	<i>see note 7</i>
Tuning Table	F0 18 0A dd 05 F7	262 bytes
Program Map Request	F0 18 0A dd 06 F7	<i>see note 8</i>
Program Map Data	F0 18 0A dd 07 F7	262 bytes
Master Setting Request	F0 18 0A dd 08 F7	
Version Request	F0 18 0A dd 0A F7	<i>see note 1</i>
Configuration Request	F0 18 0A dd 0C F7	<i>see note 2</i>
Instrument List Request	F0 18 0A dd 0E F7	<i>see note 3</i>
Preset List Request	F0 18 0A dd 12 F7	<i>see note 4</i>
MMA Tuning Dump	F0 7E dd 08 01 tt <name (16 ascii)> ... F7 <i>see note 5</i>	
User Beat Data Request	F0 18 0A dd 30 ll mm F7	ll= beat # lsb mm = msb
Song Beat Data Request	F0 18 0A dd 32 ll mm F7	ll= beat # lsb mm = msb

••• 281 bytes per preset
(272 data + 9 MIDI header)

TRANSMITTED SYSTEM EXCLUSIVE COMMANDS

<i>Command</i>	<i>Message</i>	<i>Comments</i>
Preset Data	F0 18 0A dd 01 ll mm CS F7 <i>ll = preset # lsb mm = msb cs = checksum</i>	
Parameter Value	F0 18 0A dd 03 pl pm vl vm F7 <i>pl = parameter # lsb pm = msb vl = value lsb vm = msb</i>	
Tuning Table	F0 18 0A dd 05 F7	<i>TT data = 256 bytes</i>
Program Map Data	F0 18 0A dd 07 F7	see note 8
Config. Message	F0 18 0A dd 0D pl pm s1 l1 m1 s2 l2 m2 F7	see note 2
Instr. List	F0 18 0A dd 0F (14 bytes per instr.) ... F7	see note 3
Preset List	F0 18 0A dd 13 (13 bytes per preset) ... F7	see note 4
Set User Beat Data	F0 18 0A dd 31 ll mm ll mm ll mm ll mm F7	
Set User Song Data	F0 18 0A dd 33 ll mm... F7 <i>ll, mm Song Beat # (0-27)</i>	<i>80 bytes</i> see note 11

1st ll mm pair = beat # 0-99
 2nd pair = tempo 0-240
 3rd pair = X factor -36 to +36
 4th pair = preset # 0-639

• Note 1 - Version Request

This command allows identification of machine type and software revision. Planet Phatt will respond to the request with the version data: F0 18 0A dd **0B** ss r1 r2 r3 F7
 r1, r2, r3 = software revision # in ascii (decimal point between r1 & r2).
 ss = E-mu module type, 02 = Orbit, 03 = Planet Phatt

• Note 2 - Configuration Message

This MIDI command is used to identify the sound sets in a given Planet Phatt. The configuration request command is:
 F0 18 0A dd **0C** F7

Planet Phatt will respond to this command with the configuration message: F0 18 0A dd **0D** pl pm 0D l1 m1 0E l2 m2 F7
 where pl and pm are the lsb and msb of the total number of presets, s1 and s2 are the ID numbers of the sound sets contained in this unit, and n1=l1, m1 and n2=l2, m2 represent the lsb and msb of the number of instruments in each sound set. If no expansion set is present, s2 will be 7F and n2 will be zero.

Planet Phatt Sound Set IDs = 13 & 14 (0D & 0E - hex)

- **Note 3 - Instrument List**

This MIDI command allows external software to upload the instrument list as an array of ASCII strings. The instrument list request command is:

F0 18 0A dd **0E** F7

Planet Phatt will respond to this command with the instrument list message:

F0 18 0A dd **0F** (14 bytes per instrument) F7

The instruments are transmitted in the same order they appear to the user on Planet Phatt. Note that a given instrument's position in this list may be different from its actual number within the sound set.

instrument entry: il im (11 ascii bytes) 00

Each instrument entry in the list consists of the actual instrument number (as defined in "Sound Sets" - note 9) in lsb, msb format, followed by the instrument name (11 ascii characters plus a zero terminator) for a total of 14 (decimal) bytes. The first instrument is #1 as displayed on Planet Phatt. The total number of instrument names is equal to (n1+n2) in the configuration message above.

Note that there are less than 255 instruments in the first sound set, therefore there will be a 'hole' in the instrument numbering.

- **Note 4 - Preset List**

This MIDI command allows external software to upload all preset names as an array of ASCII strings. The preset list request command is:

F0 18 0A dd **12** F7

Planet Phatt will respond to this command with the preset list message:

F0 18 0A dd **13** (13 bytes per preset) F7

Each preset name is 12 ascii characters, plus a zero terminator, for a total of 13 (decimal) bytes. The first preset is #0. The total number of preset names is equal to pp in the configuration message above.

• **Note 5 - Bulk Tuning Dump**

Planet Phatt can receive MIDI Tuning Standard dumps in addition to its own SysEx tuning table dumps. Planet Phatt will *only* transmit in its own SysEx tuning format. The MIDI Tuning Standard is as follows:

F0 7E **dd** 08 01 **tt** <tuning name (16 ascii)> ... F7

dd= device ID **tt**= tuning prog # (ignored) **tuning name** = (ignored)

... = data (xx yy zz) *frequency data for one note repeated 128x*

xx yy zz = 0xxxxxxx 0abcdefg 0hijklmn

xxxxxxx = semitone **abcdefghijklmn** = fraction of semitone in .0061 cent units. **Examples:** Middle C = 3C 00 00 A-440 = 45 00 00

• **Note 6 - Preset Data Request**

Planet Phatt presets are organized into ranks. Each rank consists of 64 presets. Planet Phatt has ten ranks of presets (0-639). Banks may be requested using the preset request command and the appropriate preset code listed below.

Rank	Preset Range	Preset Code	MIDI Message
0	0-63	1024	F0 18 0A dd 00 00 08 F7
1	64-127	1025	F0 18 0A dd 00 01 08 F7
2	128-191	1026	F0 18 0A dd 00 02 08 F7
3	192-255	1027	F0 18 0A dd 00 03 08 F7
4	256-319	1028	F0 18 0A dd 00 04 08 F7
5	320-383	1029	F0 18 0A dd 00 05 08 F7
6	384-447	1030	F0 18 0A dd 00 06 08 F7
7	448-511	1031	F0 18 0A dd 00 07 08 F7
8	512-575	1032	F0 18 0A dd 00 08 08 F7
9	576-639	1033	F0 18 0A dd 00 09 08 F7
1	64-127	-1	F0 18 0A dd 00 7F 7F F7
0	0-63	-2	F0 18 0A dd 00 7E 7F F7
0-3	0-255	-3	F0 18 0A dd 00 7D 7F F7
4-9	256-639	-4	F0 18 0A dd 00 7C 7F F7

▼ **Warning:** Do not confuse the Preset Data Request Ranks with Standard MIDI Banks. Preset Data Request Banks are **System Exclusive** requests.

• **Note 7 - Alternate Tuning**

The “user tuning table” allows any key to be tuned to an arbitrary pitch over an 8 octave range. If selected in the preset, an alternate tuning may be achieved by modifying the tuning values from the front panel or downloading a new table into the machine. The table consists of 128 words, corresponding to the MIDI key range, kept in non-volatile memory. Each word is a pitch value expressed in 1/64 semitones, offset from key number 0 (c-2). Therefore, for equal temperament, each entry in the table would be equal to its key number times 64.

• **Note 8 - Program Mapping**

MIDI program changes will normally correspond to internal preset numbers 0-127. However, the user may “re-map” any MIDI program number, assigning it to an arbitrary internal preset. This feature allows any of the internal presets to be selected from a MIDI keyboard controller.

See Program → Preset on page 26.

PRESET DATA FORMAT

Preset data is transmitted and received using the following format: The standard system exclusive header is followed by the preset number (lsb, msb), a 14 bit word for each preset parameter value (lsb, msb) starting at parameter #0 and continuing upward, a one-byte checksum, and the end-of-exclusive byte (F7). The checksum is the modulo 128 sum of all the parameter value bytes; that is, all of the data bytes following the preset number and before the checksum.

PRESET PARAMETERS

Parameter No.	Parameter Name	Range	
0-11	preset name (12 ascii characters)	32-127	
12-14	preset link 1-3	0-639	A value of -1 = “Off”
15-18	preset, link 1-3 low key	0-127	
19-22	preset, link 1-3 high key	0-127	
23	pri instrument	- - -	See Note 9
24	pri sound start offset	0-127	
25	pri tuning (coarse)	-36 to +36	
26	pri tuning (fine)	-64 to +64	
27	pri volume	0-127	
28	pri pan	-7 to +7	
29	pri delay	0-127	
30	pri low key	0-127	

MIDI SPECIFICATIONS

	<i>Parameter No.</i>	<i>Parameter Name</i>	<i>Range</i>
	31	pri high key	0-127
	32	pri alt. volume attack	0-99
	33	pri alt. volume hold	0-99
	34	pri alt. volume decay	0-99
	35	pri alt. volume sustain	0-99
	36	pri alt. volume release	0-99
	37	pri alt. volume envelope on	0-1
	38	pri solo mode	0-2
	39	pri chorus	0-15
	40	pri reverse sound	0-1
See Note 9	41	sec instrument	- - -
	42	sec sound start offset	0-127
	43	sec tuning (coarse)	-36 to +36
	44	sec tuning (fine)	-64 to +64
	45	sec volume	0-127
	46	sec pan	-7 to +7
	47	sec delay	0-127
	48	sec low key	0-127
	49	sec high key	0-127
	50	sec alt. volume attack	0-99
	51	sec alt. volume hold	0-99
	52	sec alt. volume decay	0-99
	53	sec alt. volume sustain	0-99
	54	sec alt. volume release	0-99
	55	sec alt. volume envelope on	0-1
	56	sec solo mode	0-2
	57	sec chorus	0-15
	58	sec reverse sound	0-1
	59	crossfade mode	0-2
	60	crossfade direction	0-1
	61	crossfade balance	0-127
	62	crossfade amount	0-255
	63	switch point	0-127
	64	LFO 1 shape	0-8

Parameter No.	Parameter Name	Range	
65	LFO 1 rate	0-127	
66	LFO 1 delay	0-127	
67	LFO 1 variation	0-127	
68	LFO 1 amount	-128 to +127	
69	LFO 2 shape	0-8	
70	LFO 2 rate	0-127	
71	LFO 2 delay	0-127	
72	LFO 2 variation	0-127	
73	LFO 2 amount	-128 to +127	
74	aux. envelope delay	0-127	
75	aux. envelope attack	0-99	
76	aux. envelope hold	0-99	
77	aux. envelope decay	0-99	
78	aux. envelope sustain	0-99	
79	aux. envelope release	0-99	
80	aux. envelope amount	-128 to +127	
81-86	key/vel source 1-6	0-1	See Note 10
87-92	key/vel dest 1-6	0-42	
93-98	key/vel amount 1-6	-128 to +127	
99-106	realtime source 1-8	0-9	See Note 10
107-114	realtime dest 1-8	<i>See list</i>	
115-117	footswitch dest 1-3	0-10	
118-121	controller amount A-D	-128 to +127	
122	pressure amount	-128 to +127	
123	pitch bend range	0-13	————— A value of 13 = "Global"
124	velocity curve	0-5	————— A value of 5 = "Global"
125	keyboard center	0-127	
126	submix	0-2	
127	keyboard tuning	0-5	
128	pri portamento rate	0-127	
129	sec portamento rate	0-127	
130	pri filter type	0-17	
131	pri filter Fc	0-255	
132	pri filter Q	0-15	
133	sec filter type	0-17	
134	sec filter Fc	0-255	
135	sec filter Q	0-15	

MIDI SPECIFICATIONS

GLOBAL/SETUP PARAMETERS

<i>Parameter No.</i>	<i>Parameter Name</i>	<i>Range</i>
256	MIDI basic channel	0-15
257	MIDI volume (<i>basic channel</i>)	0-127
258	MIDI pan (<i>basic channel</i>)	-8 to +7
259	current preset (<i>basic channel</i>)	0-639
260	master tune	-64 to +64
261	transpose	-12 to +12
262	global pitch bend range	0-12
263	global velocity curve	0-4
264	MIDI mode	0-3
265	MIDI overflow	0-1
266-269	controller A-D numbers	0-31
270-272	footswitch 1-3 numbers	64-79
273	mode change enable	0-1
274	device ID number	0-15
336	Global Tempo	0-255
337	Song start/stop enable	0-1
338	Beats/Song number	0-127
339	Beats/Song transpose (x factor)	±36
340	Beats/Song mode	0-3
341	X factor up	0-34
342	X factor down	0-34
343	Beat MIDI Out	0-2
344	Beat mute Key	0-127
345	Beat start key	0-127
346	Beat stop key	0-127
347	Retrigger channel	0-15
348	Retrigger rate	0-49
349	Tempo up	0-34
350	Tempo down	0-34
351	Pitch wheel scratch channel	0-17
352	Pitch wheel scratch amount	1-100
367-383	MIDI channel bank	0-4
384-399	MIDI channel enable	0-1
400-415	MIDI program change enable	0-1
416-431	mix out	0-3
512-639	MIDI program/preset map	0-511

A value of -8 = "P"

Entire message to set pan to P:

F0 18 0A dd 03 02 02 78 7F F7

A value of 0 = External Clock

0-31, 32=Mpr, 33= Pwh
34 = off

See Note 12

0=None, 1-16 chan, 17=All

Per MIDI Channel

• **Note 9 - Sound Sets**

A Planet Phatt sound set consists of sample data (sound ROMs), plus additional instrument data in the program ROMs. Each sound set has a unique ID number. The sound sets for Planet Phatt are #13 & #14.

It is necessary to include the sound set number as part of the instrument number when exchanging data. The complete instrument number contains two fields: bits 8-12 specify the sound set (0-31) and bits 0-7 specify the instrument within the sound set (0-255).

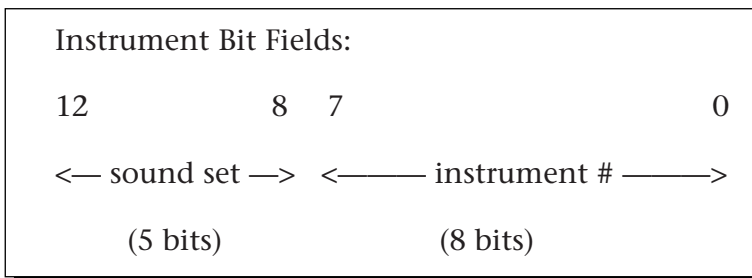

Within any given sound set, the first instrument is #1 and #0 selects "None".

The "magic numbers" **3328 & 3584** represents the start number for the two banks of Planet Phatt instruments. To calculate the complete instrument number follow the instructions below.

SysEx Instr. No. (Bank 1) = **3328 + Planet Phatt Instr. No.**

Next you must convert the SysEx instrument number to a 14-bit MIDI number. See the information on the following pages.

Example:

Suppose we want to change the instrument to **I003** SE Sub 3

- 1) $3328 + 3 = \mathbf{3331}$ ($3328 + Instr. No.$)
- 2) $3331 \div 128 = 26 \text{ r-}3 = \mathbf{26}$ (ignore remainder)
- 3) 26 in Hex = **1A** = msb
- 4) remainder 3 in Hex = **03** = lsb
- 5) SysEx Instrument Number =

lsb	msb
03	1A

The complete message to change the primary instrument to #03:
F0 18 0A dd 03 17 00 03 1A F7

••• **Magic Numbers**

3328 = Instruments 1-242

3584 = Instruments 243-482

- **Note 10 - Patchcord Destinations**

The order in which patchcord destinations appear on the screen does not necessarily match the SysEx ordering. This is necessary for various reasons, one being to maintain Proteus compatibility.

Key/Velocity Controllers

MIDI value	Destination
0	Off
1	Pitch
2	Pri. Pitch
3	Sec. Pitch
4	Volume
5	Pri. Volume
6	Sec. Volume
7	Attack
8	Pri. Attack
9	Sec. Attack
10	Decay
11	Pri. Decay
12	Sec. Decay
13	Release
14	Pri. Release
15	Sec. Release
16	Crossfade
17	LFO 1 Amount
18	LFO 1 Rate
19	LFO 2 Amount
20	LFO 2 Rate
21	Aux. Envelope Amount
22	Aux. Envelope Attack
23	Aux. Envelope Decay
24	Aux. Envelope Release
25	Sound Start
26	Pri. Sound Start
27	Sec. Sound Start
28	Pan
29	Pri. Pan
30	Sec. Pan
31	Tone
32	Pri. Tone
33	Sec. Tone

Key/Velocity Controllers (cont)

MIDI value	Destination
34	Filter Fc
35	Pri. Filter Fc
36	Sec. Filter Fc
37	Filter Q
38	Pri. Filter Q
39	Sec. Filter Q
40	Portamento Rate
41	Pri. Portamento Rate
42	Sec. Portamento Rate

Realtime Controllers

MIDI value	Destination
0	Off
1	Pitch
2	Pri. Pitch
3	Sec. Pitch
4	Volume
5	Pri. Volume
6	Sec. Volume
7	Attack
8	Pri. Attack
9	Sec. Attack
10	Decay
11	Pri. Decay
12	Sec. Decay
13	Release
14	Pri. Release
15	Sec. Release
16	Crossfade
17	LFO 1 Amount
18	LFO 1 Rate
19	LFO 2 Amount
20	LFO 2 Rate
21	Aux. Envelope Amount
22	Aux. Envelope Attack
23	Aux. Envelope Decay
24	Aux. Envelope Release

Realtime Controllers (cont)

MIDI value	Destination
28	Pan
29	Pri. Pan
30	Sec. Pan
34	Filter Fc
35	Pri. Filter Fc
36	Sec. Filter Fc
40	Portamento Rate
41	Pri. Portamento Rate
42	Sec. Portamento Rate

• Note 11 - Set User Song Beat Data

The User Song Beat Data is arranged in the following order.

F0 18 0A dd 33 ll mm ... *ll,mm= Song Beat # (0-27)*

ll mm ll mm ll mm ll mm - Event 0's Tempo, X-Factor, Type, Repeats
 ll mm ll mm ll mm ll mm - Event 1's Tempo, X-Factor, Type, Repeats
 ll mm ll mm ll mm ll mm - Event 2's Tempo, X-Factor, Type, Repeats
 ll mm ll mm ll mm ll mm - Event 3's Tempo, X-Factor, Type, Repeats
 ll mm ll mm ll mm ll mm - Event 4's Tempo, X-Factor, Type, Repeats
 ll mm ll mm ll mm ll mm - Event 5's Tempo, X-Factor, Type, Repeats
 ll mm ll mm ll mm ll mm - Event 6's Tempo, X-Factor, Type, Repeats
 ll mm ll mm ll mm ll mm - Event 7's Tempo, X-Factor, Type, Repeats
 ll mm ll mm ll mm ll mm - Event 8's Tempo, X-Factor, Type, Repeats
 ll mm ll mm ll mm ll mm - Event 9's Tempo, X-Factor, Type, Repeats
 ... F7 (EOX)

If this command is being received: it is ignored if the Song Beat number is greater than 27. Repeats are clipped to (1 to 65), with 65 = infinite.

Type Field:

0-99	Play Beat 0-99
100-127	To Song 0-27
128	Stop
129-137	To Event # (0-8)

• Note 12 - Retrigger Channel Values

0-31 = MIDI Controller 0-31, 32 = Mono Pressure, 33 = double whole notes, 34 = double whole note triplets, 35 = whl, 36 = whl-trip, 37 = half, 38 = half-trip, 39 = 1/4, 40 = 1/4-trip, 41 = 1/8, 42 = 1/8 trip, 43 = 1/16, 44 = 1/16 trip, 45 = 1/32, 46 = 1/32 trip, 47 = 1/64, 48 = 1/64 trip (96th notes), 49 = Off

••• Master menu "Send User Beat Data" sends Set User Beat Data for all 100 beats, followed by Set User Song Beat Data for all 28 songs.

▼ **Warning:** Event 0 MUST be a Play Beat. Wrong data will substitute "Play Beat 0".

Phatt won't allow a "To Event" to the same or future event. Wrong data will force to "Stop Song"

Please read this warranty, as it gives you specific legal rights.

Length of Warranty

This warranty covers all defects in materials and workmanship for a period of one year from the date of purchase by the original owner, provided that the Warranty Registration Card is filled out and returned to E-mu Systems within 14 days from the date of purchase. Cases may arise where E-mu's Service Department or one of E-mu's authorized service centers will ask for a copy of your sales receipt to facilitate warranty service. Please keep your purchase receipt in a safe place.

How To Obtain Warranty Service

If your instrument requires warranty service, it may be done by any authorized E-mu service center in the country in which you purchased the product ("Country of Purchase"). If you are unable to locate a service center in your Country of Purchase, please contact E-mu Systems Service Department at (408) 438-1921. They will either refer you to an authorized service center in your Country of Purchase or ask that you return your instrument to the factory. When returning an instrument to the factory, you will be issued a Return Authorization number (RA). Please label all cartons, shipping documents and correspondence with this number. E-mu suggests you carefully and securely pack your instrument for return to the factory or authorized service center. Mark the outside of the shipping carton clearly with your RA number. Send to E-mu Systems, Inc. 1600 Green Hills Road, Scotts Valley, California, 95066. You must pre-pay shipping charges to the service location. E-mu Systems will pay return shipping fees. You will be responsible for any damage or loss sustained during shipment in any direction.

E-mu Systems does not cover:

- Damages due to improper or inadequate maintenance, accident, abuse, misuse, alteration, unauthorized repairs, tampering, or failure to follow normal operating procedures as outlined in the owner's manual.
- Deterioration or damage of the cabinet.
- Damages occurring during any shipment of the product for any reason.
- An E-mu product that has in any way been modified by anyone other than E-mu Systems, Inc.

Limitation of Implied Warranties

This limited warranty is the sole and exclusive warranty provided by E-mu. No other warranties are expressed or implied. E-mu Systems specifically disclaims the implied warranties of merchantability and fitness for a particular purpose.

Exclusion of Certain Damages

E-mu Systems' liability for a product found defective is limited to repair or replacement of the unit, at E-mu's option. In no event shall E-mu Systems be liable for damages based on inconvenience, whether incidental or consequential, loss of use of the unit, loss of time, interrupted operation or commercial loss, or any other consequential damages.

Some states do not allow limitation of the duration of implied warranties or the exclusion or limitation of incidental or consequential damages, so the above limitations and exclusions may not apply to you.

3/96

Symbols

19-tone tuning 77

2-pole 45

A

Aftertouch 39

See also Pressure

Alternate tunings 77

Alternate volume envelope 40, 62, 86

Attack 40, 70

Auxiliary envelope 70

B

Balance 12, 61, 48

Banks, preset 4, 12

Basic operation 9

Basic sampling system diagram 18

Basic setup 5

Block diagram, Planet Phatt 73, 74

Beats control 32

Beat maps 106-108

Beats MIDI out 31

Beats mode 13, 33

C

Channel pan 12

Channel ripoff 94

Channel volume 12

Character chart 58

Chorus 64, 85

Coarse tuning 61

Constant tempo 33

Constant T, X, P 33

Continuous controller 52

Contour

See Envelope generator

Crossfade

Amount 67

Balance 66

Direction 66

Mode 65

Cross-switch 65

Curves, velocity 50

Cutoff frequency 44, 69

D

Data entry control 11

DCA 48

Decay 40, 70

Delay

Envelope 40, 70

Instrument 63

LFO 71

Demo sequences 33

Dimensions: 109

Display 34

E

Edit menu select 11

Editing presets 84

Effect returns 8

Effect devices 7, 8, 94

Enter 11

Envelope generators 40, 70

Equal tuning 77

Event number 15

External Clock mode 32

External processing 94

F

Factory presets 4, 12, 96-100

Factory settings, beat mode 33

Fc 44, 69

Filter 43-47, 67-69

Filter modulation 43

Fine tuning 61

Footswitch 29, 75

G

Gamelan tuning 77

Glide

See portamento

Global

Bend 22

Tempo 32

Velocity curve 22, 23

H

Headphone 5

Hold 40, 62, 70

Home/Enter button 11

I

ID number 24

Instrument 4, 48, 84

Listing 101-105

Selection 59

Inverting 42

J

Javanese tuning 77
Just C tuning 77

K

Key number 59, 67
Key range 59
Key velocity 39, 73
Keyboard
 Center 50, 77
 Connection 5-7
 Layered 37, 60, 78, 83
 Modulation 39, 49, 73, 77
 Pressure 39
 Split 37, 60, 78, 83
 Tuning 21, 31, 77

L

Layering 37, 60, 78, 83
Legato 64
LFO 38, 41, 71
 Delay 71
 Rate 71
 Synced 42, 71
 Variation 72
Link preset 37, 78, 83
Low frequency oscillators 38, 41, 71
Low pass filter 44, 67, 87

M

Main controls 11
Main outputs 6
Master menu select 11
Master settings, send 30
Master tune 21
MIDI 52
 Activity LED 11
 Bank select 25
 Basic info 52, 53
 Connections 5, 7
 Channel selection 12
 Controller 27, 39, 52
 Controller amount 75
 Controller assign 27
 Controllers A-B-C-D 27, 52, 75
 Enable 25
 Footswitch assign 29
 Implementation chart 110
 In 5-7
 Mode 24
 Mode change 25

MIDI (cont)

 Mono mode 24
 Multi mode 24
 Omni mode 24
 Out 6, 30
 Out, beats 31
 Overflow 25
 Poly mode 24
 Program → Preset 26
 Realtime controllers 27, 52, 74, 75
 Recording SysEx data 30, 112
 Specifications 110-125
 System exclusive 112-125
 Thru 7
 MIDI-patch 42
Mix outputs 24, 54, 78
Modulation 38
 destination 38
 source 39-41, 73, 74
Mono mode 24
Mono output 5
Morph 46
Morphing filter 46, 68
Multi-mode 24
Multi-timbral operation 14

O

Omni mode 24
Organization, basic 4
Output impedance: 109
Output level: 109
Outputs 5, 6, 7, 78
Overflow 25

P

Pan 12, 51, 61
 Channel pan 12
 Modulation 73, 74
 Preset pan 61
Patch 42
Performance setup 7
Pitch bend range 22, 75
Pitch wheel 39
Pitch wheel scratch 29
Poly mode 24
Poly key pressure 39
Portamento 64
 Rate 64
Power 8, 109
 110/220 8
Power switch 11

Preset 4, 12
 Change 27
 Factory preset listing 96-100
 Links 78
 Mapping 26
 Naming 58
 Recording to a sequencer 30
 Saving 79
 Selection 12
 Pressure amount 75
 Primary 4
 Filter type 67
 Instrument 59
 Key range 59
 Program/Preset map 26
 Programming basics 35

Q

Q 45, 69

R

Random 41, 71
 Rate
 LFO 71
 Portamento 64
 Realtime modulation 39, 51
 Record scratch mode 29
 Release 40, 70
 Resonance 45, 69
 Retrigger 28
 Reverse sound 63
 Ripoff 94

S

Sample & hold 41, 71
 Sample playback rate: 109
 Sample start point 63, 74
 Save preset 79
 Sawtooth 41
 Scratch mode 29
 Secondary 4
 Instrument 59
 Key range 60
 Send MIDI data 30
 Send/Return cables 7
 Setup 5-7
 Sequencing 92
 Multi-timbral 17
 Sequencer hookup 6
 Signal flow 43, 73, 74
 Sine wave 41

Solo mode 64
 Song examples 16
 Song mode 13, 15
 Song start/stop 31
 Sound start 63, 74
 Split keyboard 37, 60, 78, 83
 Square wave 41
 Stereo outputs, 5-8, 54
 Studio setup 6
 Sub 1 & 2 outputs 8, 54
 Submix returns 7, 8, 94
 Sustain
 Envelope generator 40, 70
 Pedal/footswitch 75
 Synced LFO 42, 71
 Synth mode 64
 SysEx 30, 112-125

T

Technical specifications 109
 Temperament 31, 77
 Tempo 14, 32
 Tempo control 28
 Tone 43, 48, 73
 Transpose
 Beats 13
 Keyboard 22
 Tremolo 71
 Triangle wave 41
 Tuning
 Master 21
 Preset coarse & fine 61
 Tuning table 31, 77

U

User beat data, send 30
 User key tuning 31
 User presets
 Location 4
 Send 30
 User settings, beats 33

V

Vallotti tuning 77
 Variation, LFO 72
 Velocity, def 39
 Velocity curve 50
 Global velocity curve 76
 Velocity modulation 39, 49, 73
 Vibrato 71
 Viewing angle 34

Volume
MIDI channel volume 12
Preset volume 61
Volume control 11

W

Warranty 126
Waveform, LFO 41
Weight: 109
Wind controller mode 64

X

X-factor 13, 14
X-factor control 27
Xfade 65
Xswitch 65

Z

Z-Plane Filter 46

PROPS

Special thanks to the following developers for their contributions to making Planet Phatt:

Ron E. Beck

David Ritch

Mark Blasquez

Clark Salisbury

Eric Cunningham

Andrew Schlesinger

Jay Dittamo

Robert Semrow

G.L.O.W.O.r?m.

Michael Von Struble

Chris Lang

Sam Ward

Rob Lodes

Fred Z.

Jason Miles

... and all the Emu folks who helped.

E-MU SYSTEMS WARRANTY REGISTRATION (U.S.A.)

Please take the time right now to fill out and mail in this warranty registration card. By doing so, you are assured of receiving news of all updates, product bulletins, new product accessories and manual revisions. Thank you.

MODEL NUMBER: _____

SERIAL NUMBER: _____

PRODUCT NAME: _____

DATE PURCHASED: _____ DEALER'S NAME: _____

YOUR NAME: _____ TELEPHONE: _____

ADDRESS: _____

CITY: _____ STATE: _____ ZIP CODE: _____

We would appreciate your answers to the following questions:

For what activities will you use this E-mu product? (Check all that apply)

MUSIC

- Composition
 Performance
 Recording

FILM/VIDEO PROD.

- Scoring
 FX/Sound Design
 Multimedia Authoring

PERSONAL/HOBBY

- Performance Solo?
 Home Recording
 Just Messing Around

What percentage of your income is derived from music? 100% 50-99% 25-49% 1-24% 0%

Where did you first learn about this E-mu product? _____

Why did you choose this E-mu product? _____

How would you rate your MIDI knowledge? Expert Moderate Struggling to Learn

Will you use this product with a computer? Yes No

If so, what type? PC (or compatible) Mac Atari Amiga Other _____

Which of the following magazines do you read?

- | | | | |
|--|--|---|---|
| <input type="checkbox"/> Keyboard (1) | <input type="checkbox"/> Modern Drummer (12) | <input type="checkbox"/> Sound-On-Sound (19) | <input type="checkbox"/> Keys (25) |
| <input type="checkbox"/> Musician (2) | <input type="checkbox"/> Studio Sound (14) | <input type="checkbox"/> EQ (21) | <input type="checkbox"/> Audio Media (26) |
| <input type="checkbox"/> Mix (5) | <input type="checkbox"/> Music Technology (16) | <input type="checkbox"/> Future Music (22) | <input type="checkbox"/> Canadian Musician (27) |
| <input type="checkbox"/> Downbeat (9) | <input type="checkbox"/> Post (17) | <input type="checkbox"/> Keyboards (Germany) (23) | <input type="checkbox"/> Film & Video (28) |
| <input type="checkbox"/> Elec. Musician (10) | <input type="checkbox"/> Millimeter (18) | <input type="checkbox"/> Home/Studio Recording (24) | |

What other products would you like to see from E-mu? _____

How would you describe your buying experience?

- Splendid Very Good Fair Poor Abysmal

Additional Comments: _____

Please fold this card along the dotted line and return within 10 days of your purchase. Thank-you.

Fold Here



NO POSTAGE
NECESSARY IF
MAILED IN THE
UNITED STATES

BUSINESS REPLY MAIL
FIRST CLASS PERMIT NO. 209 SANTA CRUZ, CA

POSTAGE WILL BE PAID BY ADDRESSEE

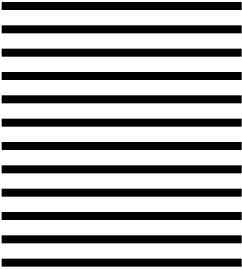

E-mu Systems, Inc.
1600 GREEN HILLS ROAD
P.O. BOX 660015
SCOTTS VALLEY, CA 95067-0015

